

# Solarico®

INNOVATIVE  
PLASTIC COMPOSITE  
NEW GENERATION

HYGIENIC WATER HEATER  
DRAINBACK SOLAR STORAGE TANK  
STRATIFIED SEPARATOR ACCUMULATOR

## GENERAL BENEFITS

- HEAT PUMP READY
- SUPPORT HEATING WITH SOLAR
- HEART OF THE SYSTEM

## ALL IN ONE

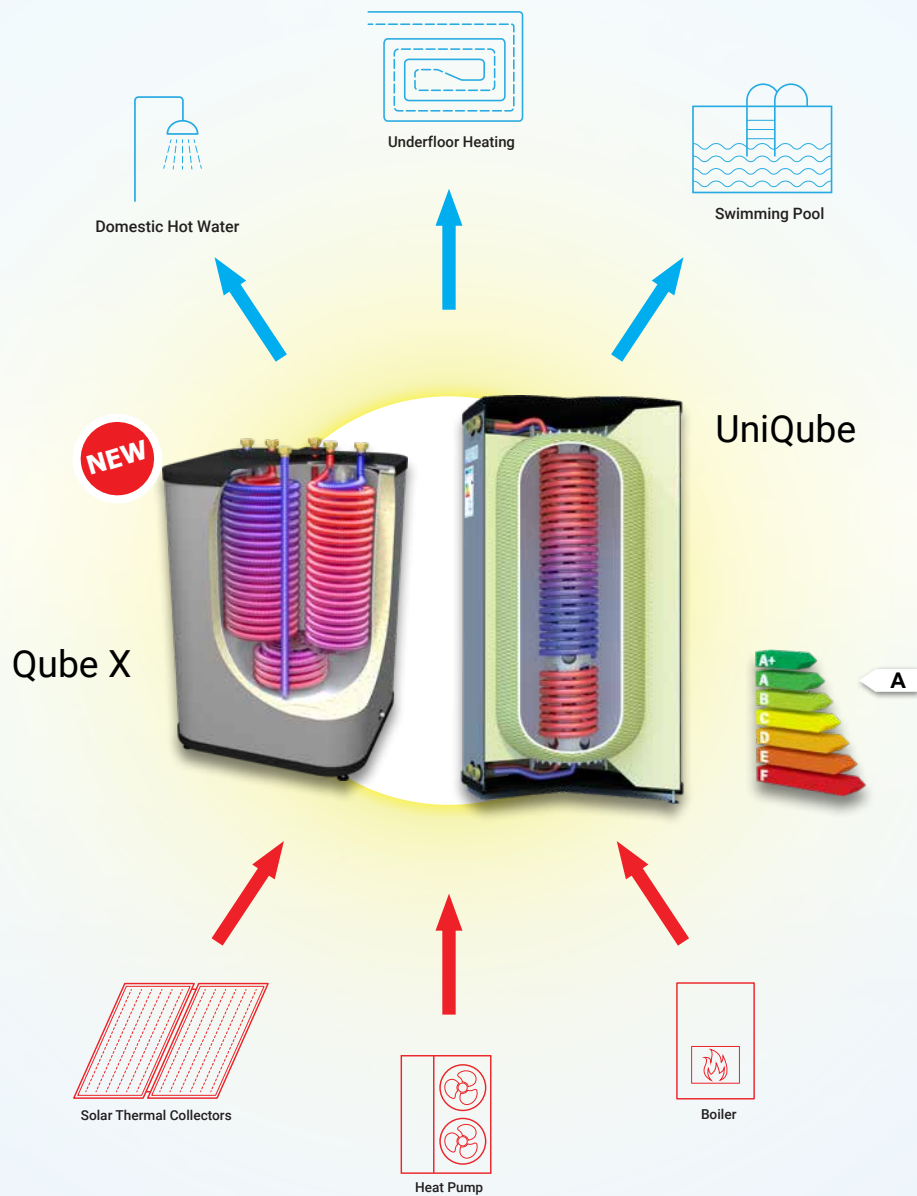

*Solutions Beyond the Sun  
...by Solarico*



It's amazing, just 1 second of the Sun's energy output would power the world for 500,000 years!

**We store it, you use it!**

# Solarico Production

Leading The Modern Era



A-class energy efficiency



Decades of warranty and reliability

## Capturing the sun

Solarico Production started with the UniPlate solar collectors. We developed custom designed robot for welding the UniPlate's full-plate absorber. These absorbers are resistant to mechanical distortions and are most effective in the class of flat panels.

Copper to copper ultrasonic welding results in high thermal transmission joints that are chemically and physically stable for decades.

4 mm thickness tempered safety solar glass makes UniPlate resistant to tough outer impacts and its low iron structure provides close to 100% solar heat capturing.

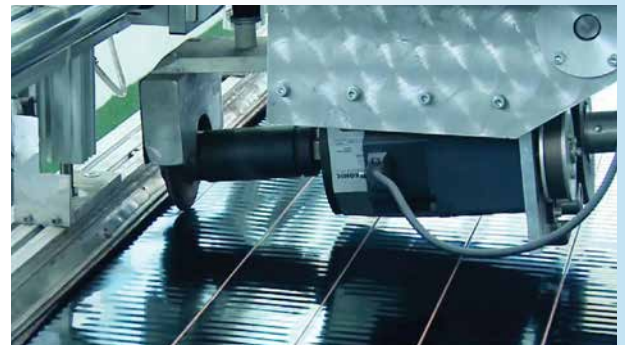

## Ongoing improvement

### Overcoming conventional energy storage

Looking to the future, combining knowledge and experience, we got inspired to start our own production line of the advanced heat storage tank - the UniQube.

Lifting to the highest level of energy efficiency, and setting a new standards for heat storage tanks.



## Shaking the stagnant tech - composites instead of steel

### Lightweight, safe, durable

It starts with computer controlled automated process of rotational molding the cylindric inner tank, using the cross-linkable PEX plastic

- It's impermeable and thermally inert material
- Temperature resistant, with outstanding compressive and tensile properties

Then we wind it with glass-fiber composite in order to achieve a top strength, so it becomes a tank - stable to higher working pressures.

The combination of these materials is resistant to harshest environment and corrosion on both sides of the tank.

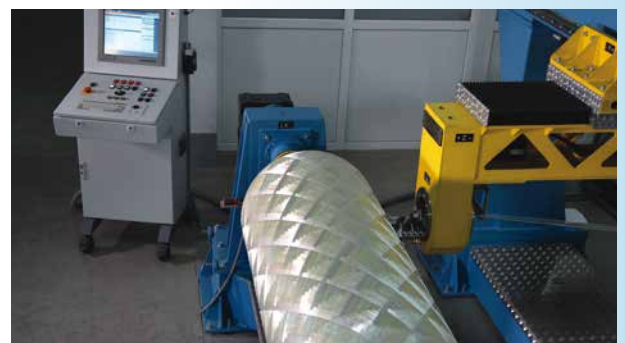

# Easy way to use the power of the sun

*The essentials of solar thermal systems*

Looking to the future, we found that such skills and experience could be put to the efficient manufacture of new products in the renewable energy market. We use our long time experience for developing our own products that best meet the needs of our customers. With the most up to date technology, and with our power of innovation and solar expertise, we produce and sell products which are following the highest standards in industrial production of thermal solar collectors.

Solarico's systems are developed on the years of experience and practical skills, produced with the newest production technologies that guaranties the best efficiency and quality and fast return of overall investment.



## Advanced automation technology

Solarico developed specially designed robot for welding the UniPlate's full plate absorber.

Process of welding absorber in one piece and its automation guaranties optimal productivity.

## Impressive energy apsorbtion, stability and reliability

UniPlate's absorber is made of corrugated full plate copper foil, with selective surface coating and ultrasonically welded on 12 copper tubes. Full plate absorbers are resistant to mechanical distortions and are most effective in the class of flat panels.

Copper to copper ultrasonic welding produce high thermal transmission joints that are chemically and physically stable for decades.

4 mm thickness tempered safety solar glass makes UniPlate resistant to tough outer impacts and its low iron structure provides minimum reflection of the sun rays.



## Full plate selective coated high tech collectors

- Solarico UniPlate collectors
- Full plate high performance absorber
- High transmission tempered safety glass
- Optimal insulation
- Aluminium casing
- Easy to install
- 10 years guarantee
- Stability and reliability

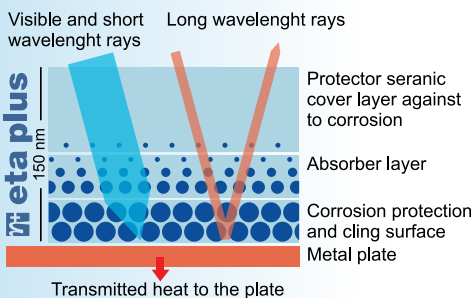

The latest technology of selective coated absorbers that have been used for the UniPlate 2.5 SB series solar collectors transfer the sun radiation heat in maximum level and minimize the reflection loss which decrease the efficiency.

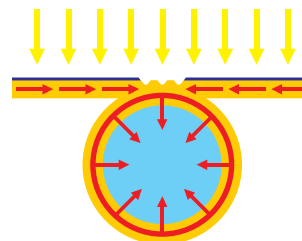

Ultrasonic welding method which is the one of the most modern and latest technologies has been used to connect the selective coated absorber surface to the riser pipes.

# Performance as our voice

Up to 50% energy savings

When using solar thermal panels, storage tank is the central part of any heating system, guaranteeing its efficiency. UniQube has improved energy efficiency class "A", usable hot and clean water, light-weight, corrosion resistant, space saving design. The plastic tank is reinforced by filament winding of fiber glass. Using this technology for our storage tank, we lift it a level above the conventional storage tanks.

UniQube provides hygienically safe water heated by any kind of heat source, or combination of more heat sources, depending on customer needs. The inside heat diffusion is limited by stainless steel tube diffusion protection. Using the same technology, Solarico is also producing a new generation of composite expansion vessels, pressure and water treatment tanks, and heat exchangers for pool heating.

## Hygienic hot water

The Solarico UniQubes consumes energy for hot water only at the moment when the user request it. It saves 10% ÷ 30% compared to conventional water heaters. Cold drinking water is connected to the inlet of stainless steel heat exchanger, and its outlet is connected to the tap. Water flows thru when the tap is open and gets instantly the heat from the water of the heating system that is stored in the tank.

This ondemand heating is also limiting proliferation of Legionella.



## Thermal Stratification

Thermally layered hot water tanks are saving up to 25% of energy, compared to diffused heated tanks. The hottest water takes the top layer and is first used. Therefore the time between heat input and heat output is low, minimizing the standing heat losses. It also improves the time of heat delivery from the heat source to the heat consumers, providing best comfort for the final users.

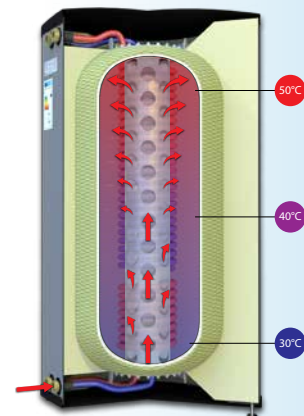

## Buffer – Heat accumulator

It stores the surplus of heat coming out of sun, absorbs all the peaks of heat sources. It is also storing the heat produced during the cheap electricity rate and use it during the expensive rate. It scores 10% ÷ 30% energy savings.



## “Drain Back” Solar Heating

We input a free solar energy into the heating system. The more sun heat we store, the bigger energy savings, and the lower payback time of the investment.

Combining UniPlate collectors and UniQube hot water storage tanks it is possible to input from  $7kW_{th}$  ÷  $20kW_{th}$  sun heat into the heating system, using only one UniQube.





**NEW**

# Qube X

*Unpressurized hot water storage tank and drain back reservoir*

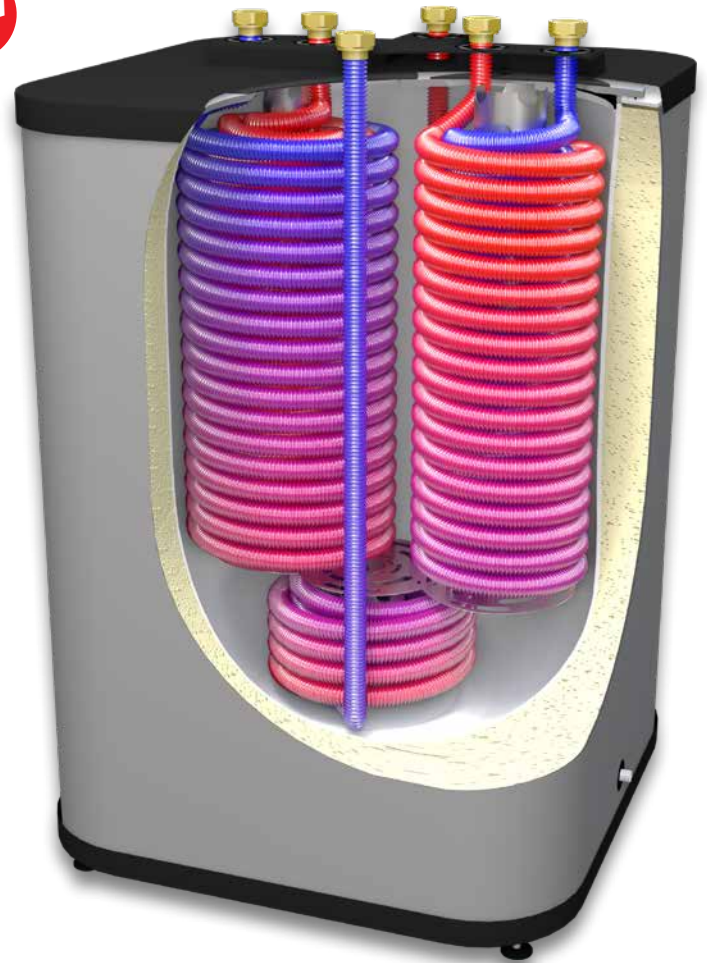

## APPLICATION

- Renovations of hot water systems
- Large hot water outputs
- Clean hot water in clean spaces
- Where the budget is limited
- Energy efficient installations
- Harsh environment

## BENEFITS

- Lightweight
- Easy to manipulate
- Installer friendly
- Lower transport costs
- Optional electric heater backup (1 or 2)



## HOW IT WORKS

There is polyethylene tank inside filled with energy transfer medium and up to 3 heat exchangers:

- one heat exchanger is used for providing hygienic hot water
- other 2 heat exchangers may be used for connecting:
  - 2 heat sources, or
  - 1 heat source + 1 heat consumer
- the tank is not pressurized
- the tank may be used as solar drain back tank
- the inside medium may be used as a solar drain back medium
- the inside medium transfers the energy among the heat exchangers and solar collectors



## HYGIENIC ON-DEMAND DOMESTIC HOT WATER

- 10÷30% energy savings due to on-demand principle of heating of water for domestic use. It uses energy to heat up the water only when the user opens the tap
- Improved Legionella prevention through the use of continuous flow principle
- Application - in the HORECA industry, kindergartens, schools, hospitals, and residential areas

## WATER MEDIUM FOR HEAT TRANSFER INSTEAD OF GLYCOL

- Water has superior heat transfer properties compared to propylene or ethylene glycol because of a high thermal capacity and low viscosity.
- Unlimited Application - anywhere, including installations where contamination potential is not allowed
- Highest Solar Thermal Efficiency - Water has higher thermal conductivity compared to glycol
- Minimum Maintenance - No need for concentration check up and potential glycol based corrosion
- Low Cost - Glycol solutions are more expensive than water, plus necessary equipment for its handling and maintenance

Qube X		220	400
D (diameter)	(mm)	620	890
H1 (height)	(mm)	845	845
H (height)	(mm)	1100	1100
a (width)	(mm)	725	960
Pivot measurement	(mm)	1320	1460
Gross tank capacity	(l)	220	400
Weight (with exchangers)	(kg)	80	100
Connections I, J		5/4"	
S2 Solar sensor position	(mm)	450	
S3 DHW sensor position	(mm)	250	
S4 Heating sensor position	(mm)	250	
S5 Overheating protection position	(mm)	250	
Max. working temperature	(°C)	90	
Nominal flow rate (all exchangers)	(l/min)	20	
Max. flow rate (all exchangers)	(l/min)	30	
Max. working pressure (all exchangers)	(bar)	10	
Max. test pressure (all exchangers)	(bar)	15	
<b>Solar heat exchanger</b>			
Connections F, G		5/4"	
Capacity	(l)	8,68	8,68
Output area	(m <sup>2</sup> )	2,67	2,67
<b>DHW heat exchanger</b>			
Connections A, B		5/4"	
Capacity	(l)	17,55	23,25
Output area	(m <sup>2</sup> )	5,35	7,07
<b>Heating exchanger</b>			
Connections C, E		5/4"	
Capacity	(l)	6,78	9,31
Output area	(m <sup>2</sup> )	2,10	2,87

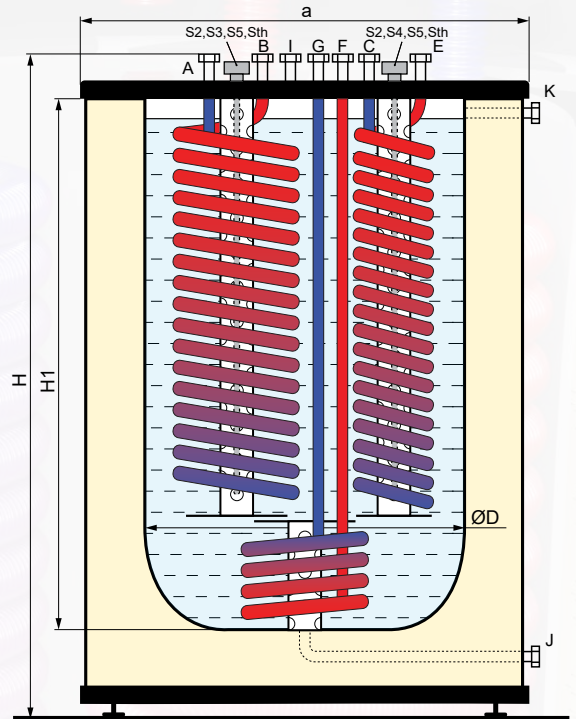

- A - Cold water in
- B - Hot water out
- C - Heating in
- E - Heating out
- F - Solar in
- G - Solar out
- I - Solar Drain Back in
- J - Solar Drain Back out
- K - Overflow pipe

- S2 - Solar sensor
- S3 - DHW sensor
- S4 - Heating sensor
- S5 - Overheating protection sensor
- Sth - Electrical thermostat

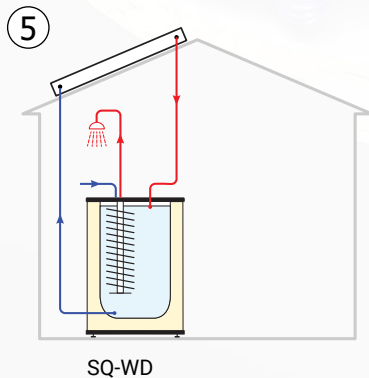
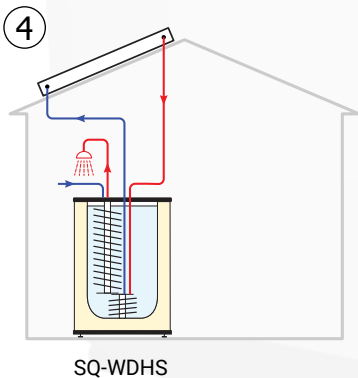
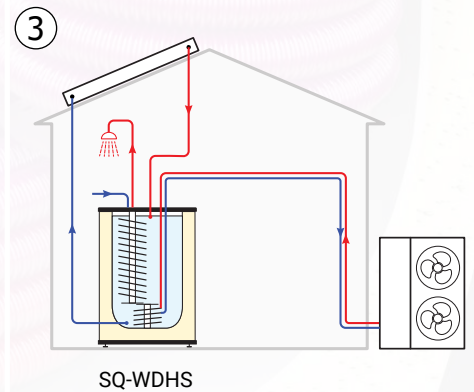
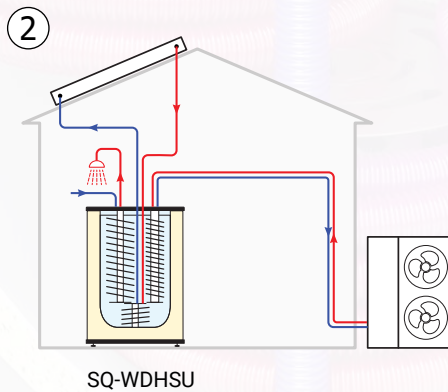
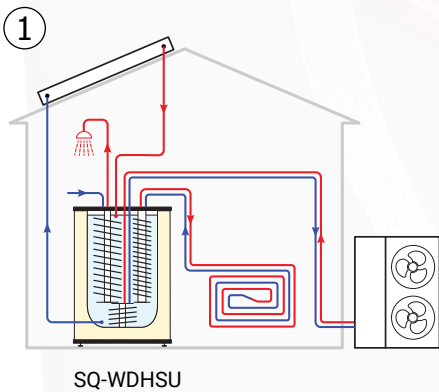

1. Hygienic Hot Water + Solar Drain Back + Heat Pump + Solar support for space heating
2. Hygienic Hot Water + Solar Pressurized + Heat Pump
3. Hygienic Hot Water + Solar Drain Back + Heat Pump
4. Hygienic Hot Water + Solar Pressurized
5. Hygienic Hot Water + Solar Drain Back



# UniQube

## Hot water storage tank

- Continuous flow domestic water heater, a hygienic storage tank
- Domestic hot water heat exchanger made of stainless steel inox 316 l corrugated pipe
- Solar heat exchanger made of stainless steel inox 316 l corrugated pipe
- Device for stratification of the heat
- Hydraulic separator between the heat source circuit and the heating circuit
- Equipped with four sleeves for sensors
- Polyurethane high quality insulation, specific in very limited fire contribution, class b2 according to din 4102
- All flanges are replaceable and it can be modified to any other type of storage tank if necessary
- Electric heater backup (optional)



**SQ-BPSW**  
Combined storage tank



**SQ-BPW**  
Domestic water heater



**SQ-BPS**  
Solar storage tank



**SQ-BP**  
Stratification storage tank



**SQ-B**  
Buffer storage tank



UniQube		310	440	800
D (diameter)	(mm)	620	620	890
H1 (height)	(mm)	1300	1730	1730
h (connectors)	(mm)	1320	1750	1750
H (height)	(mm)	1570	2000	2000
a (width)	(mm)	725	725	960
Pivot measurement	(mm)	1730	2130	2219
Net tank capacity	(l)	290	413	773
Approx. weight	(kg)	104	130	160
Connections C,E,I,J		5/4"		
Max. working temp.	(°C)	90	90	90
Max. working pressure	(bar)	6	6	6
Max. test pressure	(bar)	9	9	9
S2 Solar sensor position	(mm)	1110	1550	1550
S3 DHW sensor position	(mm)	600	900	900
S4 Heating sensor position	(mm)	140	140	140
S5 Overheating protection	(mm)	140	140	140
Nominal flow rate (all exchangers)	(l/min)	20		
Max. flow rate (all exchangers)	(l/min)	30		
Max. working pressure (all exchangers)	(bar)	10		
Max. test pressure (all exchangers)	(bar)	15		

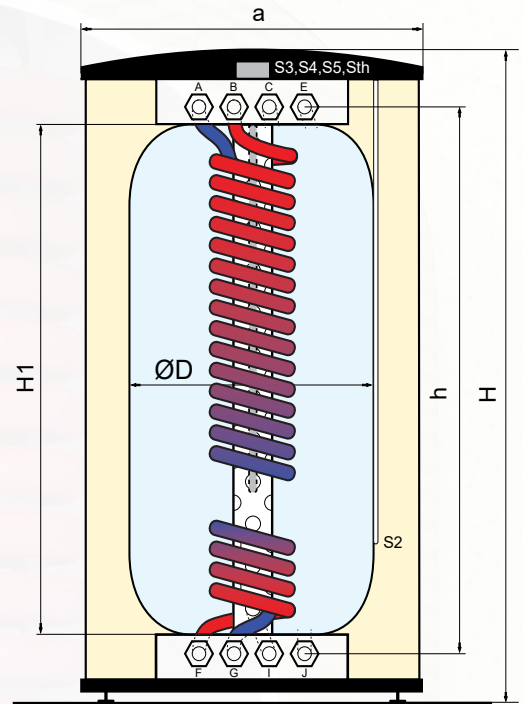

### Solar heat exchanger

Connections F, G		5/4"		
Capacity	(l)	2,85	4,12	4,12
Output area	(m <sup>2</sup> )	1,05	1,43	1,43

### DHW heat exchanger

Connections A, B		5/4"			
Capacity	SQ-BPSW	(l)	16,15	21,86	21,86
	SQ-BPW		17,42	25,66	25,66
Output area	SQ-BPSW	(m <sup>2</sup> )	5,06	6,78	6,78
	SQ-BPW		5,44	7,93	7,93

A - Cold water in      F - Solar in  
 B - Hot water out    G - Solar out  
 C - Heating in        I - Boiler in  
 E - Heating out       J - Boiler out

S2 - Solar sensor  
 S3 - DHW sensor  
 S4 - Heating sensor  
 S5 - Overheating protection

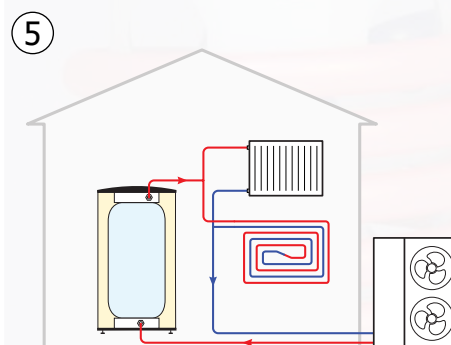
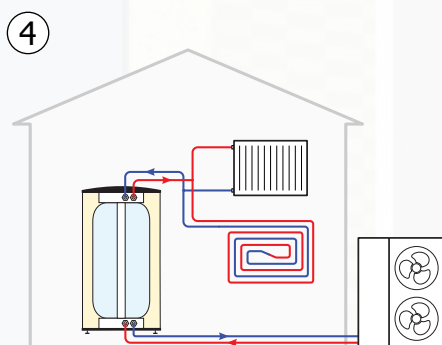
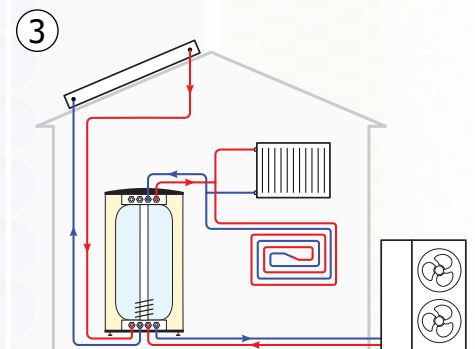
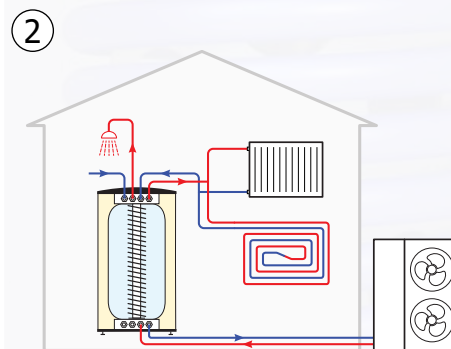
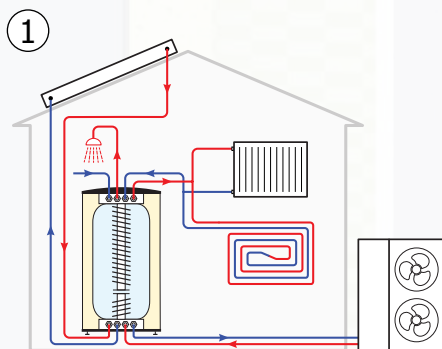

1. SQ-BPSW - Combined storage tank
2. SQ-BPW - Domestic water heater
3. SQ-BPS - Solar storage tank
4. SQ-BP - Stratified separator storage tank
5. SQ-B - Buffer storage tank



# UniQube 6C

*Energy savings all-in hot water storage tank*



## ADVANTAGES

- Easy integration of any type of heat source
- Easy integration of any type of heat consumers
- Total hydraulic separation of 6 circuits
- Available for 310, 440 and 800 liter accumulation tanks
- Simplified pipeworks
- Minimized heat losses

## BENEFITS

- Smooth thermostat control over all heat consumers
- Solution for systems with multiple heat sources
- Extended lifetime of the system components
- Cheaper installation
- Lower energy bill
- Space saving installation
- Electric heater backup (optional)



## WHAT IS THE 6C VERSION OF UNIQUBE?

It is any UniQube model produced with the possibility to connect 6 heating circuits. Now it is possible to integrate 3 heat sources + 3 heat consuming circuits in direct connection with the heat accumulator.

## MORE THAN CONVENTIONAL HEAT PUMP SYSTEMS

UniQube 6C integration improves system performance by at least 25%. It may integrate and buffer high-temperature heat sources added to the heat pump systems. Solar thermal supports the heat pump work. It supplies multiple heat consumers like domestic hot water, swimming pools, radiator, or underfloor heating.

## NOW IT IS EASY TO DESIGN AN ENERGY-SAVING SYSTEM

The system designers that will include UniQube 6C models in their projects, will offer a high-efficiency heating system for the end user.

UniQube 6C SQ-BPSW		310	440	800
D (diameter)	(mm)	620	620	890
H1 (height)	(mm)	1300	1730	1730
h (connectors)	(mm)	1320	1750	1750
H (height)	(mm)	1570	2000	2000
a (width)	(mm)	725	725	960
Pivot measurement	(mm)	1730	2130	2219
Net tank capacity	(l)	290	413	773
Approx. weight	(kg)	104	130	160
Connections C,E,P,Q,I,J,T,U		5/4"		
Max. working temp.	(°C)	90	90	90
Max. working pressure	(bar)	6	6	6
Max. test pressure	(bar)	9	9	9
S2 Solar sensor position	(mm)	1110	1550	1550
S3 DHW sensor position	(mm)	600	900	900
S4 Heating sensor position	(mm)	140	140	140
S5 Overheating protection	(mm)	140	140	140
Nominal flow rate (all exchangers)	(l/min)	20		
Max. flow rate (all exchangers)	(l/min)	30		
Max. working pressure (all exchangers)	(bar)	10		
Max. test pressure (all exchangers)	(bar)	15		

**Solar heat exchanger**

Connections F, G		5/4"		
Capacity	(l)	2,85	4,12	4,12
Output area	(m <sup>2</sup> )	1,05	1,43	1,43

**DHW heat exchanger**

Connections A, B		5/4"		
Capacity	(l)	16,15	21,86	21,86
Output area	(m <sup>2</sup> )	5,06	6,78	6,78

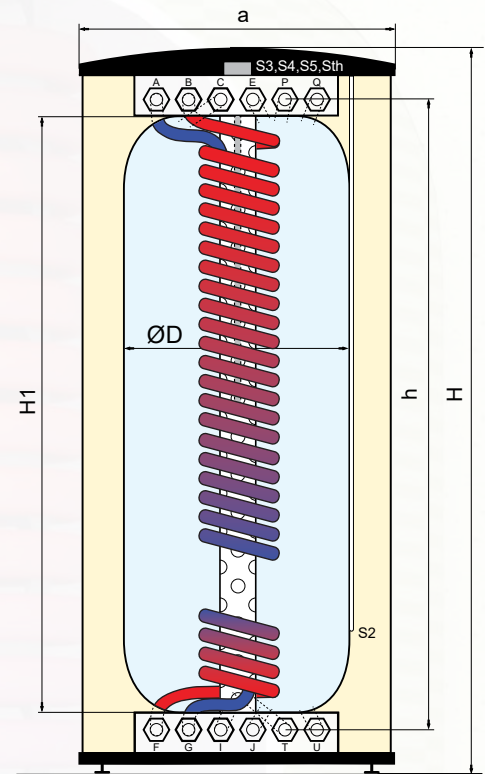

- A - Cold water in
- B - Hot water out
- C - Heating in
- E - Heating out
- P - Heating in
- Q - Heating out
- F - Solar in
- G - Solar out
- T - Heat Pump In
- U - Heat Pump out
- I - Boiler in
- J - Boiler out

- S2 - Solar sensor
- S3 - DHW sensor
- S4 - Heating sensor
- S5 - Overheating protection

**FOLLOWING THE KNOWLEDGE**

The UniQube 6C models are Solarico's latest project, utilizing the potential of direct connection of multiple heat circuits to the tank.

- 3 heat sources + 3 heat consumers in direct connection to the A-class energy efficient heat storage
- Heating System designs, where UniPlate solar collectors are added, result in notable energy savings because of 100% free solar thermal energy
- 4 times more efficient collectors per m<sup>2</sup>, compared to photovoltaic panels, in a sense of sun energy utilization
- Usage of thermal collectors as a real support for the heating system by up to a fantastic 50%, and even more
- "Drain Back Solar" option, solar system is 100% stable

1. UniQube 6C SQ-BPSW
2. UniQube Drain Back Reservoir DB
3. Solar collectors UniPlate 2.5 SB
4. Heat pump
5. Boiler fireplace
6. DHW
7. Radiator heating
8. Floor heating
9. Solarico Heat Exchanger SHE
10. Pool

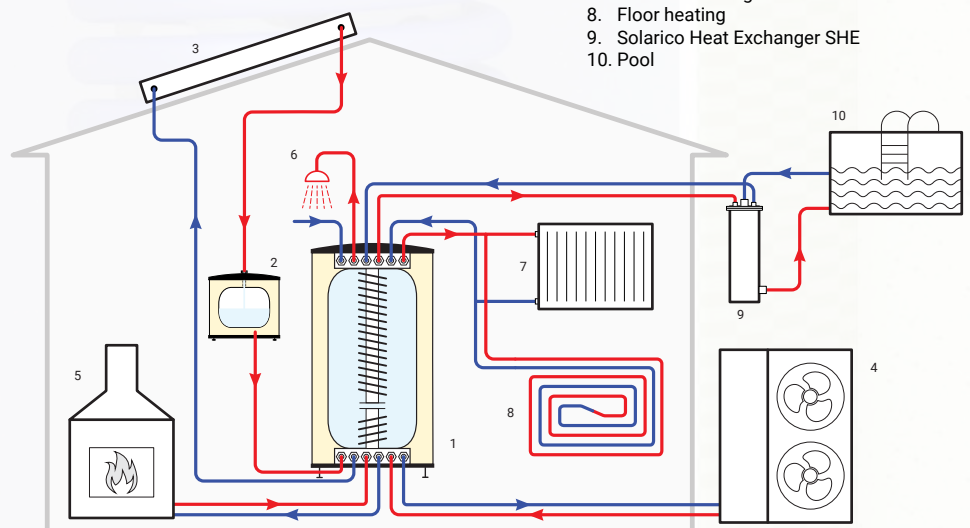



# UniQube Drain Back Reservoir

## Solar Draining Tank

- **UTILIZES MUCH MORE SOLAR ENERGY**  
because drain back solar systems can be sized with much more collectors - they absorb more solar energy providing more savings
- **SOLAR SUPPORT FOR THE HEATING SYSTEM**  
because drain back solar systems can be sized with much more collectors - this energy can be used by the heating system
- **OVERHEATING AND FREEZE PROTECTION**  
are active because of principal of work - when pump stops circulating, heating fluid from collectors is draining down into the drainage reservoir, so the only care is to do a proper piping installation
- **EASY TO INSTALL & CHEAPER INSTALLATION**  
Drain back systems do not require expansion vessels, check valve, air valve or additional overheating protection. This system can even work with water as heating fluid instead of antifreeze
- **SYSTEM STABILITY, LOW-MAINTENANCE**  
Since the fluid is drained back into the storage tank when not in use, there is no risk of stagnation or corrosion in the pipes. This significantly reduces the need for maintenance and ensures a longer lifespan for the system

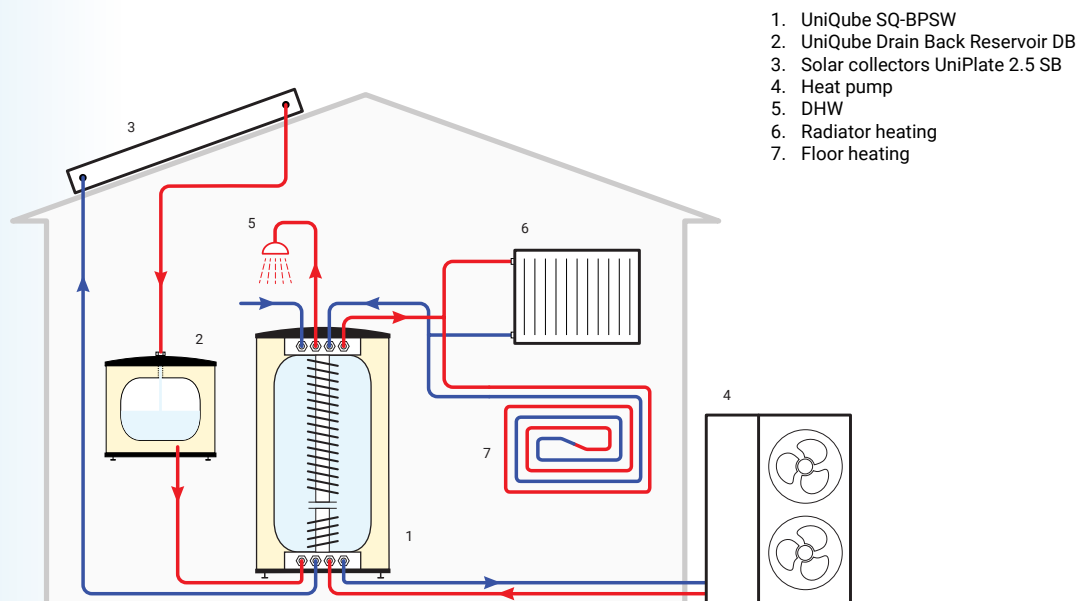

1. UniQube SQ-BPSW
2. UniQube Drain Back Reservoir DB
3. Solar collectors UniPlate 2.5 SB
4. Heat pump
5. DHW
6. Radiator heating
7. Floor heating

Integration with UniQube in home energy system

UniQube DB Reservoir		50	100	150
D <sub>1</sub> (diameter)	(mm)	600	600	600
H <sub>0</sub> (height)	(mm)	450	780	780
H <sub>2</sub> (height)	(mm)	140	350	490
a (width)	(mm)	725	725	725
Tank capacity	(l)	50	100	150
Approx. weight	(kg)	30	43	46
Connections M,N		5/4"		
Max. working pressure	(bar)	1,5	1,5	1,5
Max. test pressure	(bar)	2,5	2,5	2,5
Material		Stainless steel 304		

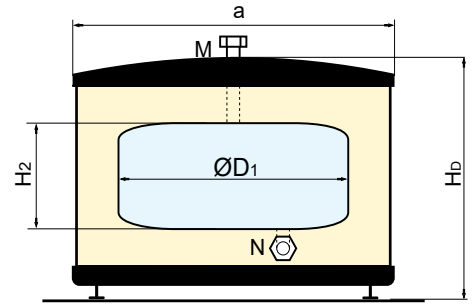

M - Solar in  
N - Drain Back out

### Idle

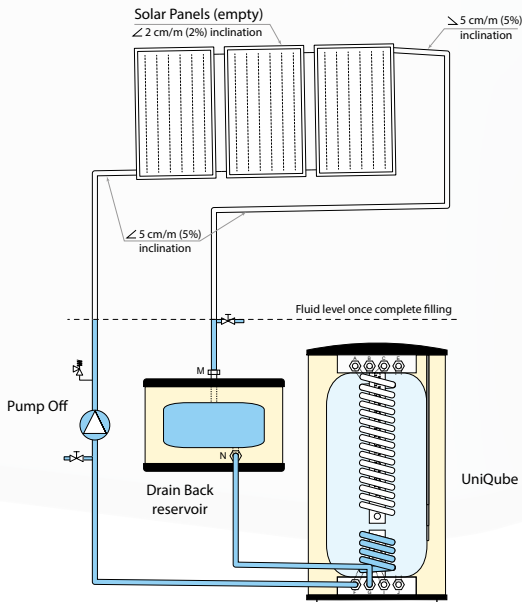

### In Operation

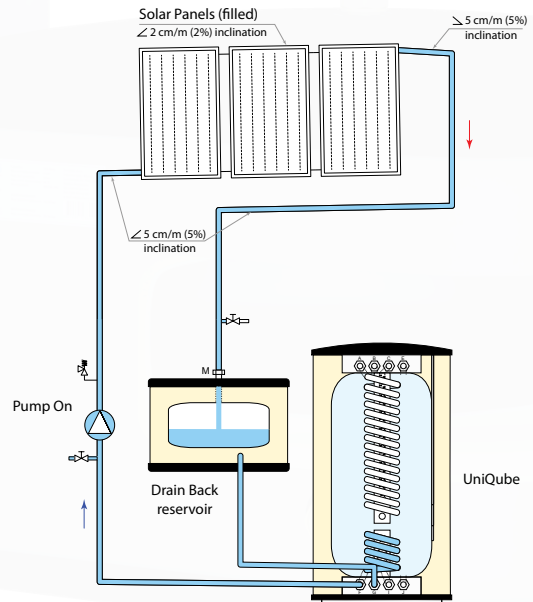

Operation modes of the DB reservoir with levels of fluid in it



# Heat Exchangers

*Stainless steel corrugated pipe*

Solarico helical coil heat exchangers were primarily designed for the production of domestic hot water of UniQube storage tanks. In order to get the most efficient hot water production, we put a lot of effort into the research and development of our heat exchangers.

We produced our design of helical coil heat exchanger, by using corrugated stainless steel pipe, as the most compact and efficient one. The tests show that these types of heat exchangers may be produced in various versions and transfer powers, for lots of applications especially in pool water heating.



## SELF-CLEANING, LESS MAINTENANCE

The material used is mirror surface finish Inox 316L. In combination with turbulencies and swirlings inside, the polished surface does not support deposits and limescale. It ensures a constant high performance and minimum maintenance throughout the entire service life.

## CUSTOM DESIGN

We provide all the experience, knowledge, and manufacturing capacity to our clients for their specific designs and projects. The heat exchangers may be customized to meet the most varied requirements and applications. The length, fittings, and overall dimensions may be customized on request.

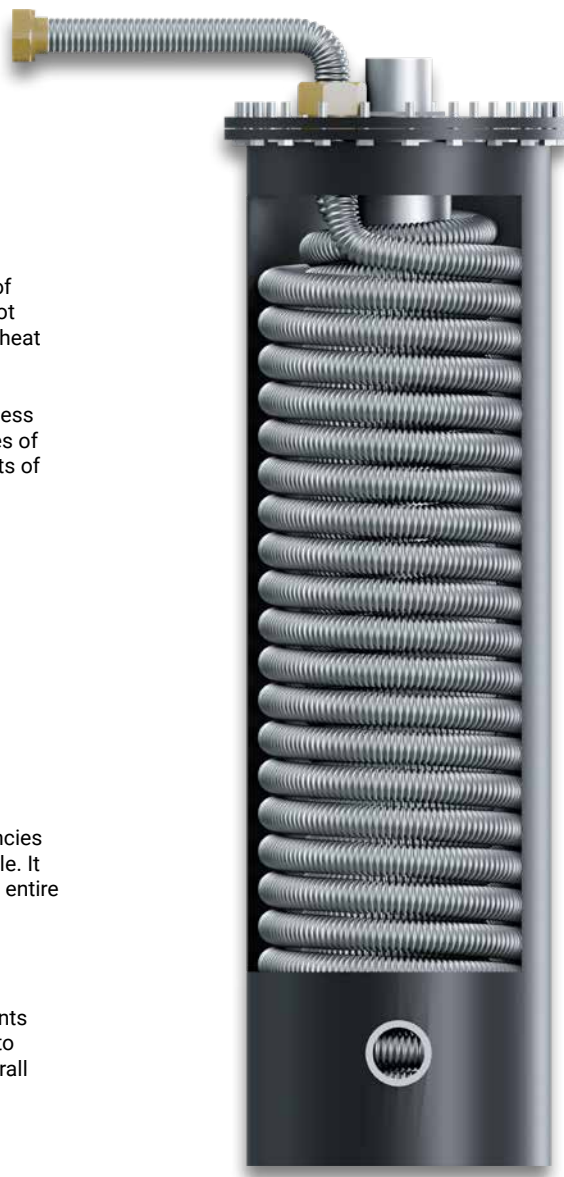

1. UniQube 6C SQ-BPSW
2. UniQube Drain Back Reservoir DB
3. Solar collectors UniPlate 2.5 SB
4. Heat pump
5. Boiler fireplace
6. DHW
7. Radiator heating
8. Floor heating
9. Solarico Heat Exchanger SHE
10. Pool

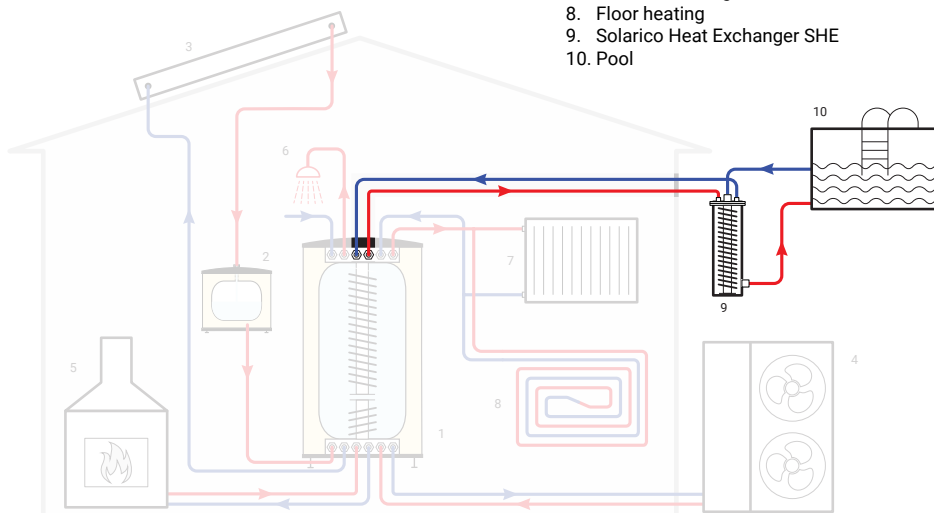

## INCREASED HEAT TRANSFER RATE

Corrugated pipe heat exchangers, provide up to 60% improved performance, compared to conventional flat-plate heat exchangers, because of:

- **Innovative fluid dynamics design** - There is a stratification tube inside, used in combination with a decentralized inlet and outlet for the pipe-surrounding fluid.
- **Geometrical design** - Choosing the right helical coil diameter, pipe diameter, and pitch dimensions are crucial to the heat exchanger performance. As the number of turns in the coil increases, the temperature drops of hot fluid also increased. The increase in the number of turns resulted in a higher rate of heat transfer.
- **Physics** - Pipe corrugations cause continuous disturbance of the boundary layer of the tube side fluid, increase the amount of turbulence, mix the thermal layers, and lower the flow speed in the middle of the pipe. These effects increase the overall rate at which heat is transferred compared to laminar flow heat exchangers.

The stratification tube inside leads the primary fluid into complete contact with the heat transfer surface, **improving efficiency by 20%**.

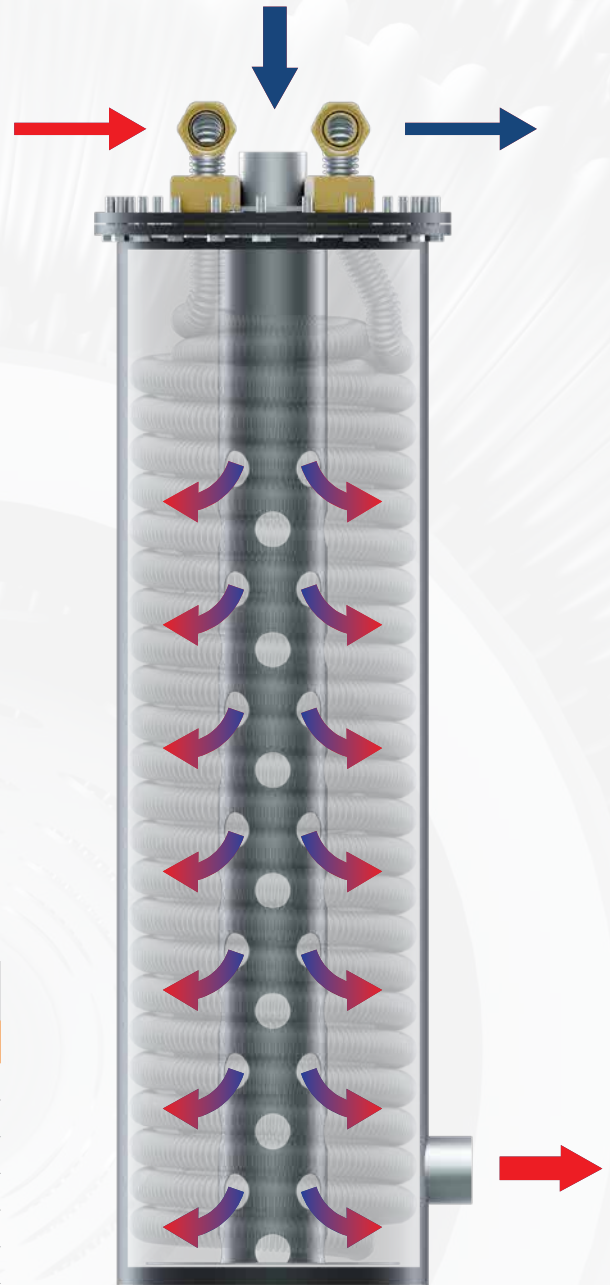

## CORRUGATED PIPE

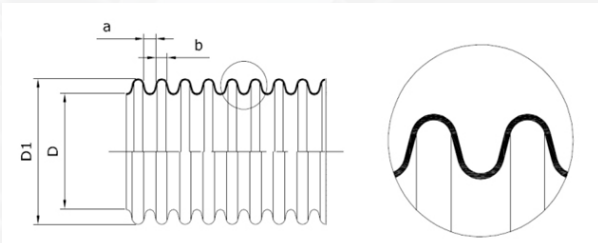

### Solarico Heat Exchangers

#### Corrugated pipe

D	(mm)	25,20			
D <sub>1</sub>	(mm)	31,60			
a	(mm)	3,20			
b	(mm)	2,00			
Tolerance		±0,30			
Operating pressure	(bar)	11			
Surface area per meter	(m <sup>2</sup> /m)	0,191			
Min. section area	(mm <sup>2</sup> )	498,76			
Volume	(m <sup>3</sup> /m)	0,6335			
Material		Inox 316L			
Heat exchanger		310U	310D	440U	440D
C <sub>1</sub> (diameter)	(mm)	300	300	300	300
C <sub>2</sub> (diameter)	(mm)	250	250	250	250
H (height)	(mm)	910	380	1140	600
L (length)	(mm)	40	40	40	40
Total surface area	(m <sup>2</sup> )	5,10	1,00	6,80	1,40
Total pipe length	(m)	26,50	5,00	35,50	7,50
Total volume	(l)	14,68	4,64	19,31	7,73
Power (up to)	(kW)	25	7	35	10
Approx. weight	(kg)	39	22	46	29
Nominal flow rate	(l/min)	20			
Maximum flow rate	(l/min)	30			
Connections E,F		6/4"			
Connections E,F - material		Stainless steel			
Connections I,J		5/4"			
Connections I,J - material		Brass			

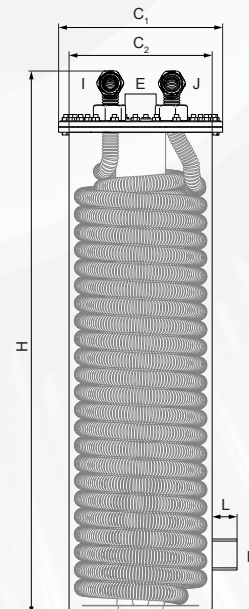



# Composite Expansion Vessels

- **HEAVY-DUTY MEMBRANE**  
Does not support the build-up of nutrients key to forming biofilms
- **AIR SPACE**  
Up to 60% less heat losses compared to membrane types, due to minimized contact surface between warm water and vessel
- **PLASTIC COMPOSITE RESERVOIR**  
Does not rust and is inactive in contact with a long list of chemicals
- **CONTAMINATION PREVENTION**  
No stagnant warm water
- **WARRANTY TERM**  
Reservoir 30 years  
Membrane 5 years

- Non-corrosive glass fiber
- Non-corrosive plastic liner
- Energy efficient air space
- Flow-through membrane

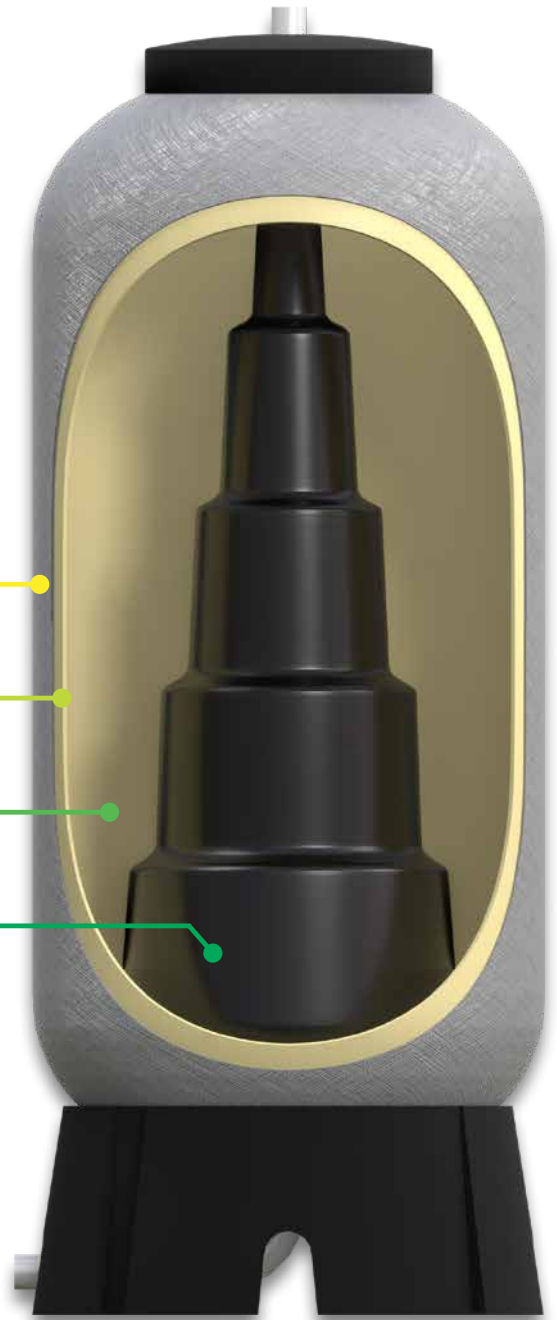

CE PED

ISO 9001  
LL-C (Certification)

30 YEARS  
QUALITY GUARANTEE

5 YEARS  
QUALITY GUARANTEE

## WHY PLASTIC-COMPOSITE EXPANSION VESSELS ARE A GOOD CHOICE?

Solarico plastic composite expansion vessels are suitable for booster systems, HVAC systems, cooling tower systems, spa systems, and evaporative condenser systems.

These expansion vessels will not corrode from the inside and outside too. There are no pieces of rust that may damage the inner membrane. The outside moisture and chemically active environment may not damage it too. That's why these are long lifetime vessels compared to conventional steel vessels.

## EXTENDED LIFETIME OF RESERVOIR AND MEMBRANE

Using this technology in the production of expansion vessels results in a long-lasting product that saves a lot of energy, and increases reliability, boosting cost-effectiveness.

- Lightweight vessels, easy to manipulate and transport
- Low heat losses
- Corrosion free





<b>Composite Expansion Vessels</b> For heating and potable water systems		310	440	800
D (diameter)	(mm)	620	620	880
H1 (height)	(mm)	1300	1730	1730
H (height)	(mm)	1500	1950	1950
a (width)	(mm)	700	700	850
b (height)	(mm)	300	300	350
Net tank capacity	(l)	310	440	800
Approx. weight	(kg)	60	75	94
Max. working temp.	(°C)	90	90	90
Max. working pressure	(bar)	6	6	6
Max. test pressure	(bar)	9	9	9
Connections A,B		up to 6/4"		

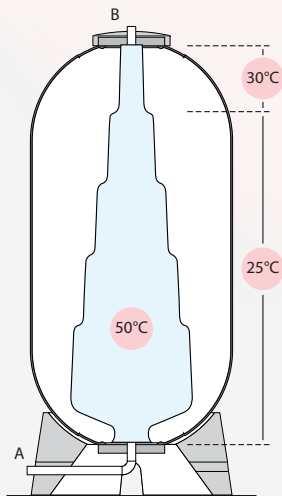
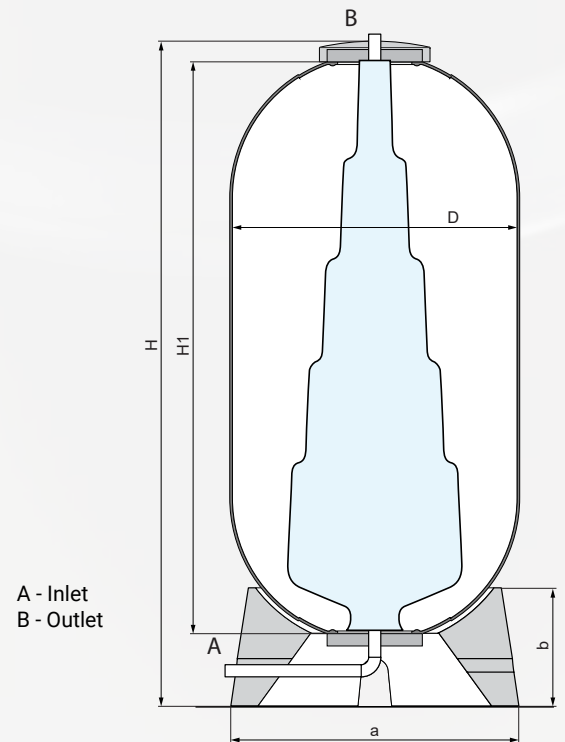

#### FOR HEATING SYSTEMS

- Up to 60%, fewer heat losses compared to diaphragm types, due to the minimized contact surface between warm water and vessel
- Low heat losses due to minimum captured quantity of warm water
- Low heat losses due to thermal inertia of a plastic-composite reservoir
- No stagnant warm water - contamination prevention
- Maintenance-free
- Limitless installation application; It can be installed in a moist environment, near the seaside, in basements, industrial space
- The heavy-duty butyl membrane does not support the build-up of nutrients key to forming biofilms
- Extended membrane lifetime. Lower elongation of our membrane provides less stress during operation
- Approved in accordance with pressure equipment guidelines 2014/68/EU

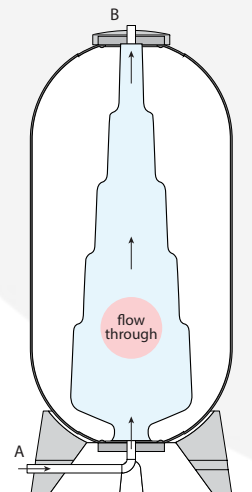

#### FOR POTABLE WATER SYSTEMS

- For potable water, pressure booster systems with or without flow-through
- Reduces start/stops of the driving pump, saving energy, maintenance costs and improving lifetime of the pump
- Ensures constant water flow, even in case of pressure fluctuations
- Water just flows through this vessel, without stagnation, and keeps its primary quality
- Absorbs water hammers
- Ensuring smooth operation, protecting other system components
- Approved in accordance with pressure equipment guidelines 2014/68/EU



# Composite Water Treatment and Pressure Tanks

## BENEFITS

- Lower power consumption because of keeping energy reserves and lowering short-cycling of the power generator.
- Extended reliability of the system, increased lifetime of equipment because of amortization of volume and pressure peaks.
- Lower maintenance cost because of the lifespan of the reservoir and increased lifetime of other equipment.
- Stable system operation. Pressure tanks handle energy backup and energy reserve
- Safe process operation

## AVAILABLE TYPES

- Volumes: 310, 440 and 800 liters
- Color: red, blue and gray
- Working pressure: 40 bar (on demand)



## PLASTIC-COMPOSITE TECHNOLOGY

The **inner plastic reservoir** is made of cross-linkable HDPE or LHDPE:

- It does not rust and is inactive in contact with a long list of chemicals
- Operates at temperatures up to 90°C
- Warranty - 30 years!

**Composite filament winding** is applied on the inner reservoir:

- It does not rust and is inactive in contact with a long list of chemicals
- Operates at temperatures up to 90°C
- Operates at pressure up to 9 bars
- Ability to short-run production - we do not ask for a minimum order quantity

## CLIENT-SPECIFIC PRESSURE VESSELS

As a manufacturer, we are able to design and manufacture pressure tanks for a wide range of pressure resistance, various types of the inner plastic liner, as well as with the most varied types and sizes of connections.

The tanks are customized to meet the most varied customer requirements and applications.

Non-corrosive glass fiber

Non-corrosive plastic liner

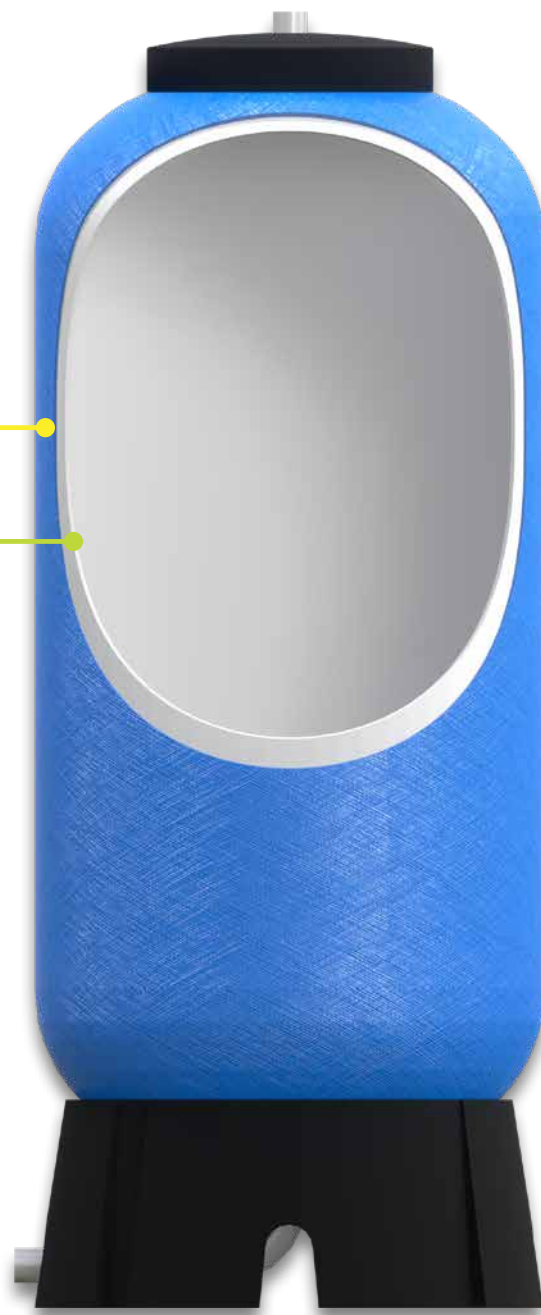

Composite Water Treatment and Pressure Tanks		310	440	800
D (diameter)	(mm)	620	620	880
H1 (height)	(mm)	1300	1730	1730
H (height)	(mm)	1500	1950	1950
a (width)	(mm)	700	700	850
b (height)	(mm)	300	300	350
Net tank capacity	(l)	310	440	800
Approx. weight	(kg)	60	75	94
Connections		6/4"		
Max. working temp.	(°C)	90	90	90
Max. working pressure	(bar)	6	6	6
Max. test pressure	(bar)	9	9	9
<b>Water treatment reservoir</b>				
Max. working temp.	(°C)	1÷50		
Max. working pressure	(bar)	10,5		
Max. test pressure	(bar)	16		

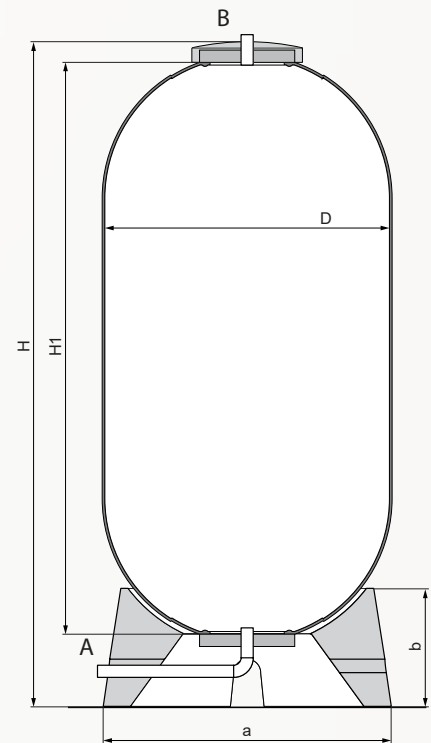

A - Inlet  
B - Outlet  
\* up to 5 connections each

## WIDE RANGE OF APPLICATIONS

- Water treatment reservoir
- Compressed air tank
- Pressurized accumulators
- Booster accumulators for fresh water systems where there is not sufficient flow rate at the open taps. Pressurized accumulator is compensating it by carrying water volume under the suitable pressure

## WATER TREATMENT TANKS

We supply our clients with custom-designed reservoirs for water treatment with LHDPE liner inside. Our reservoirs are high quality, with long warranty term guaranteed by the manufacturer. We produce them in different colors and with or without insulation which prevents the condensation.

## COMPRESSED AIR TANKS

Plastic composite tanks developed for accumulating compressed air, have huge advantages compared to conventional steel tanks. It is a lightweight reservoir easy to manipulate and install. It may be installed in the harshest environment because it will not rust in contact with water or many other condensates.

These tanks are designed the way to be safer than steel tanks. In case of bursting the glass fibers will be torn without flying metal pieces.



## FUNCTIONAL BENEFITS

- Perfect reservoir for water treatment that will not rust, keeps the water clean by constant performance throughout the entire service life
- Stores energy and redistributes when required therefore reducing installed power
- Compensates pressure peaks resulting from thermal expansion or flow rate changes in hydraulic systems
- Compensates volume changes in closed hydraulic systems, that are consequences of thermal expansion of the fluid
- Stores energy for emergency cases. Accumulation can provide sufficient energy to complete an operation or to realize a full hydraulic cycle, in case of failure of the main energy source



## UniPlate

### Solar Thermal Collectors

- Full-plate high performance copper absorber with Eta plus selective foil 0.2 mm, corrugated
- High transmission low iron tempered safety glass, 4 mm thick
- Optimal insulation
- Aluminium casing
- Easy to install
- Stability and reliability
- 10 years guarantee

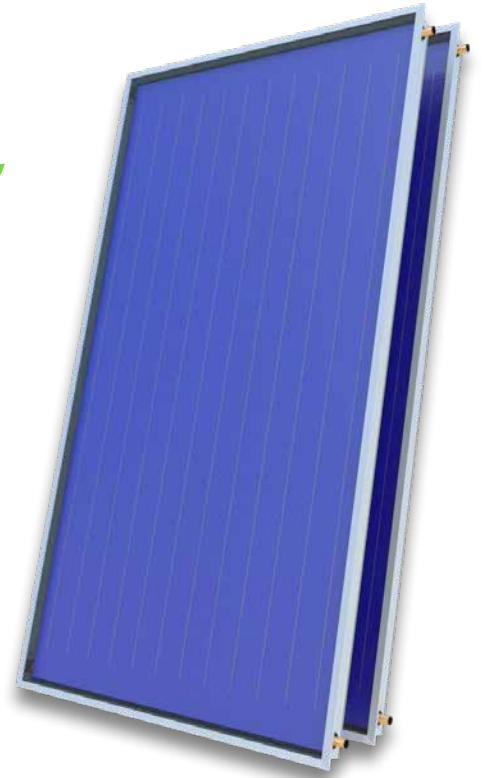

UniPlate Model		2.5 SB	2.1 SB *	2.5 SB-U *	2.1 SB-U *	2.5 SB H *	2.1 SB H *	2.5 SB HV *	2.1 SB HV *
Gross area / Light entering area	(m <sup>2</sup> )	2,49 / 2,35	2,1 / 1,95	2,49 / 2,35	2,1 / 1,95	2,49 / 2,35	2,1 / 1,95	2,49 / 2,35	2,1 / 1,95
Absorber surface (corrugate)	(m <sup>2</sup> )	2,32	1,92	2,32	1,92	2,32	1,92	2,32	1,92
Absorber material		copper sheet with "Eta plus" selective surface coating							
Absorption coefficient (Eta plus)	(%)	95 ± 2							
Emission coefficient (Eta plus)	(%)	5 ± 2							
Cu Pipe register frame	(mm)	Ø8 x 0,5							
Collective Cu pipe frame	(mm)	Ø22 x 0,8							
Absorber volume	(l)	1,7	1,3	1,7	1,3	1,7	1,3	1,7	1,3
Transparent front cover		4mm tempered solar glass							
Solar light transmission through glass	(%)	92 ± 2							
Solar energy transmission through glass	(%)	91 ± 2							
Number of connections		4	4	2	2	4	4	4	4
Connection diameter	(R)	Ø22							
Max. working / test pressure	(bar)	10 / 14							
Stagnation temperature	(°C)	199							
Insulation - back side		40 mm glass wool (50kg/m <sup>3</sup> )							
Insulation - on the sides		-							
Back area		0.5 mm embossed aluminium sheet							
Collector construction		aluminium profil AlMgSi 0,5 F22							
Welding method		ultrasonic							
Height/ Width/Depth	(mm)	2150 / 1160 / 90	2150 / 976 / 90	2150 / 1160 / 90	2150 / 976 / 90	2150 / 1160 / 90	2150 / 976 / 90	2150 / 1160 / 90	2150 / 976 / 90
Weight	(kg)	45	37	45	37	45	37	45	37
Absorber type									

\* Produced on demand for larger quantities

The base version has single glazed tempered solar glass, used in applications such as domestic hot water (DHW), industrial hot water (IHW), swimming pools, etc.

1. Anodised aluminum batten
2. Hecker T-Safe Solarfloat tempered solar glass
3. Alanod - Eta Plus Cu sheet with selective surface coating
4. Ultrasonic - welded copper absorbers
5. Mineral glass wool slab with 50 kg/m<sup>3</sup> covered by layer of black fiber glass
6. Embossed back side Al - metal sheet
7. Strong aluminum profile

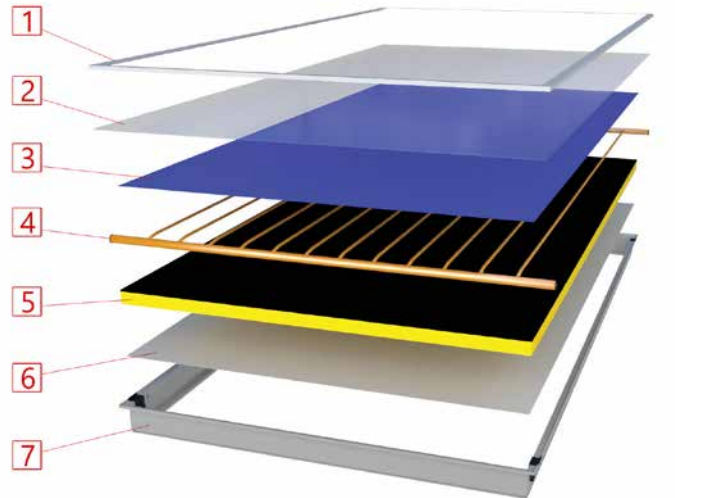

Pressure drop in Pa

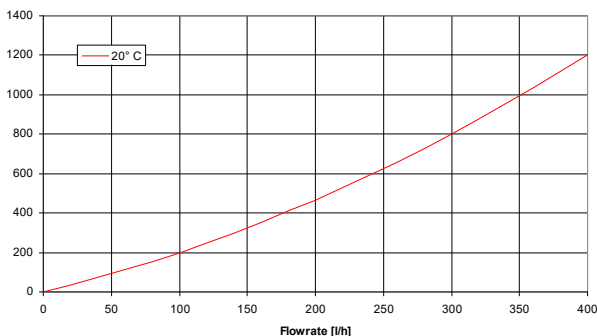

Flow rate [l/h]	0	80	160	240	320	400
Pressure drop [Pa]	0	155	352	593	877	1203

Collector efficiency for G = 800 W/m<sup>2</sup>

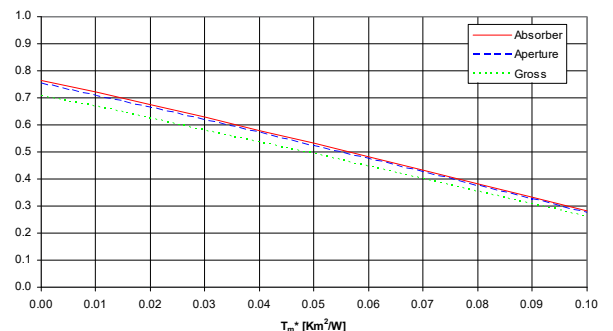

Reference area	Absorber area	Aperture area	Gross area
$\eta_0$ (-)	0.766	0.754	0.708
$a_1$ (W/m <sup>2</sup> K)	4.52	4.45	4.18
$a_2$ (W/m <sup>2</sup> K <sup>2</sup> )	0.0042	0.0041	0.0039

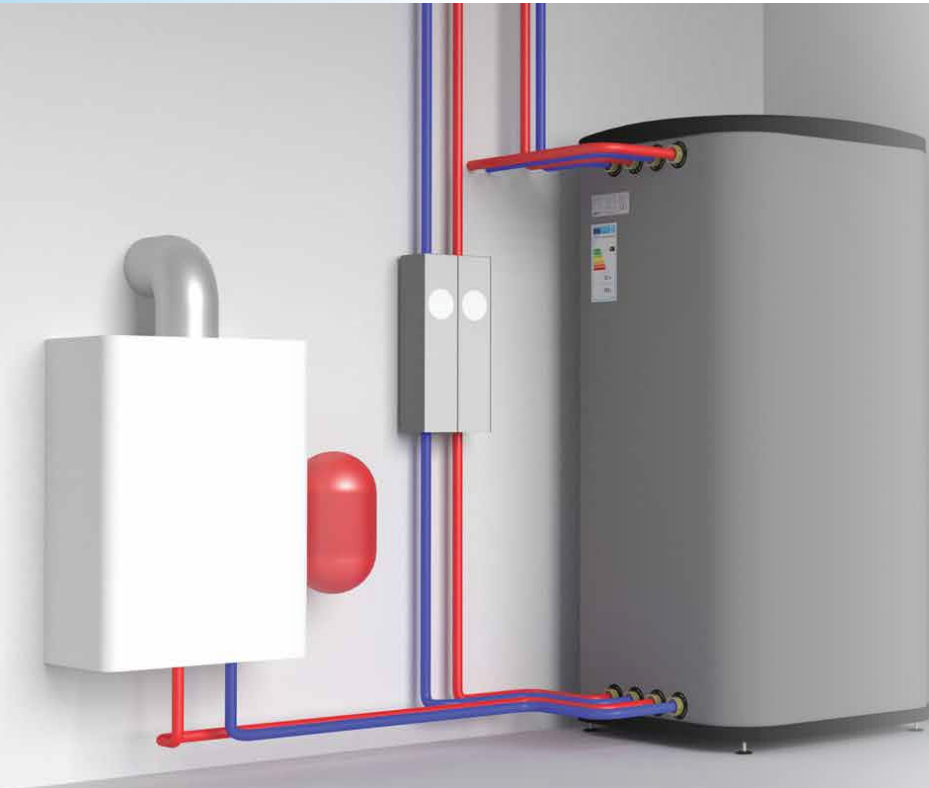

# UniQube

## Hydraulic Variants

- Central heating
- Domestic hot water
- Drain-Back
- Solar thermal panels
- Heat pumps
- Boilers
- Heat Exchanger

### Heart of the system

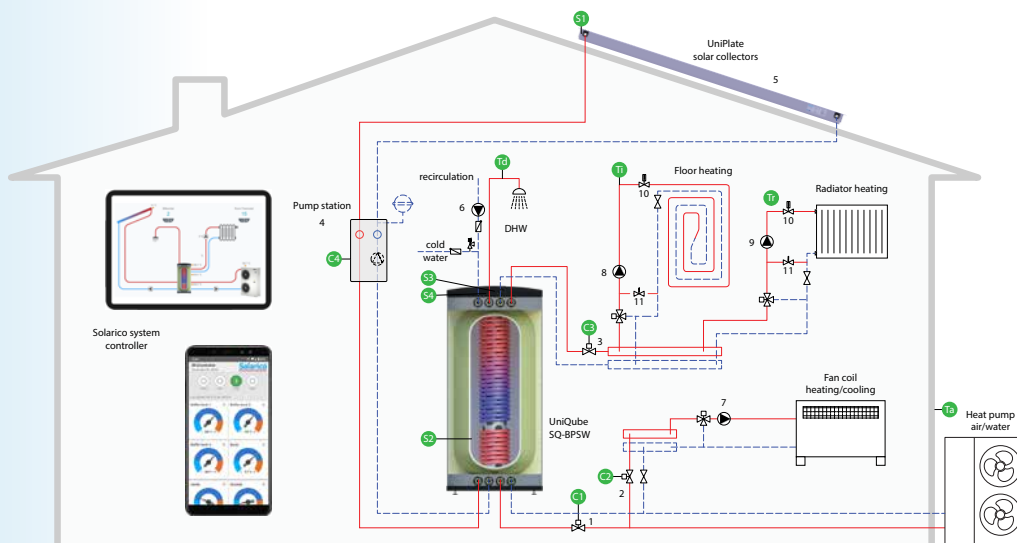

# Integration in hospitality industry

## UniQube SQ-BPSW

### BENEFITS

- Suitable for systems with variable heat consumption
- 64kW solar power for the heating system, swimming pool and domestic hot water
- No overheating in summer and no freezing in winter
- Supports installation of more collectors than conventional solar systems
- Save up to 60% energy with A-class efficient UniQubes
- Comfort temperature regulation for each room
- Improving the lifetime of circulators and heat source
- At least 20% higher annual system efficiency due to the thermal stratification
- Controlled by Solarico system controller.

This connection diagram serves only as an installation suggestion and does not replace technical planning!

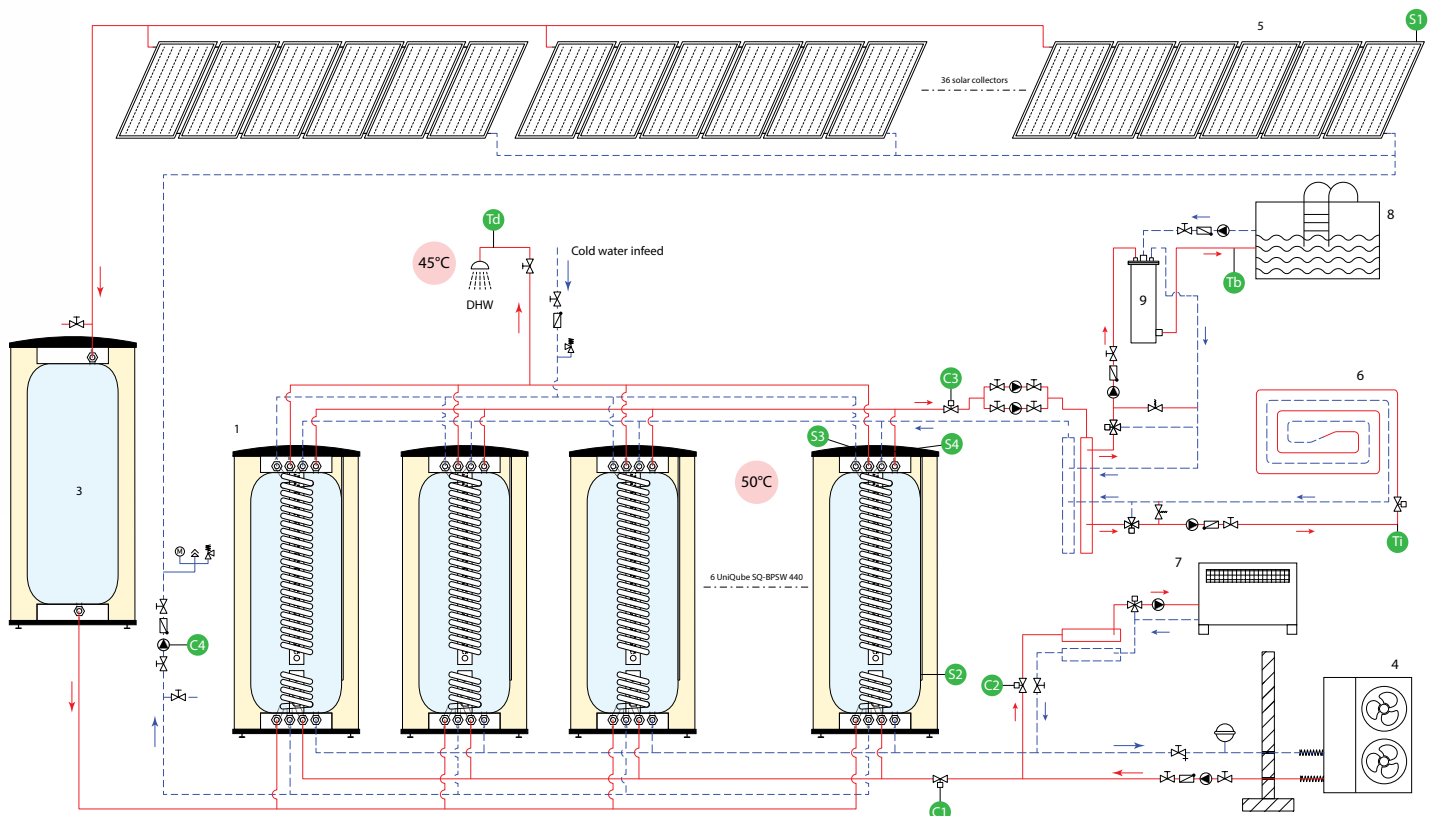

1. UniQube 6 x SQ-BPSW 440
3. UniQube SQ-B 440
4. Heat pump
5. Solar collectors UniPlate 2.5 SB
6. Floor heating
7. Fan coil units
8. Swimming pool
9. Swimming pool heat exchanger

### SENSORS & CONTROLLER ELEMENTS

- C1 - Heat pump valve
- C2 - Fan coil units valve
- C3 - Heating valve
- C4 - Solar pump and valve
- S1 - Solar panels sensor
- S2, S3, S4 - Storage tank sensors



### UNIQUEST & PRIMARY CIRCUIT CONTROL

			C1		C2	C3	C4
	WINTER	Heat pump heating - ON	S4 < 40°C	S4 > 55°C	ON	ON	ON
		Solar heating - ON	ON	OFF*			
	SUMMER	Heat pump cooling - ON	OFF		ON	OFF	ON
		Solar heating - ON	OFF				
		DHW back up heating with Electric Heater	OFF		ON	ON	
		DHW back up heating with heat pump	S4 < 40°C	S4 > 55°C	OFF	OFF	ON
			ON	OFF*			

\* Heat Pump high pressure protection if Solar DHW heating is set above 55°C

### BENEFITS

- Tanks with direct integration of 6 heating circuits - less distribution units
- 86kW solar power for the heating system, swimming pool and domestic hot water
- No overheating in summer and no freezing in winter
- Supports installation of more collectors than conventional solar systems
- Save up to 60% energy with A-class efficient UniQubes
- Comfort temperature regulation for each room
- Improving the lifetime of circulators and heat source
- At least 20% higher annual system efficiency due to the thermal stratification
- Controlled by Solarico system controller

This connection diagram serves only as an installation suggestion and does not replace technical planning!

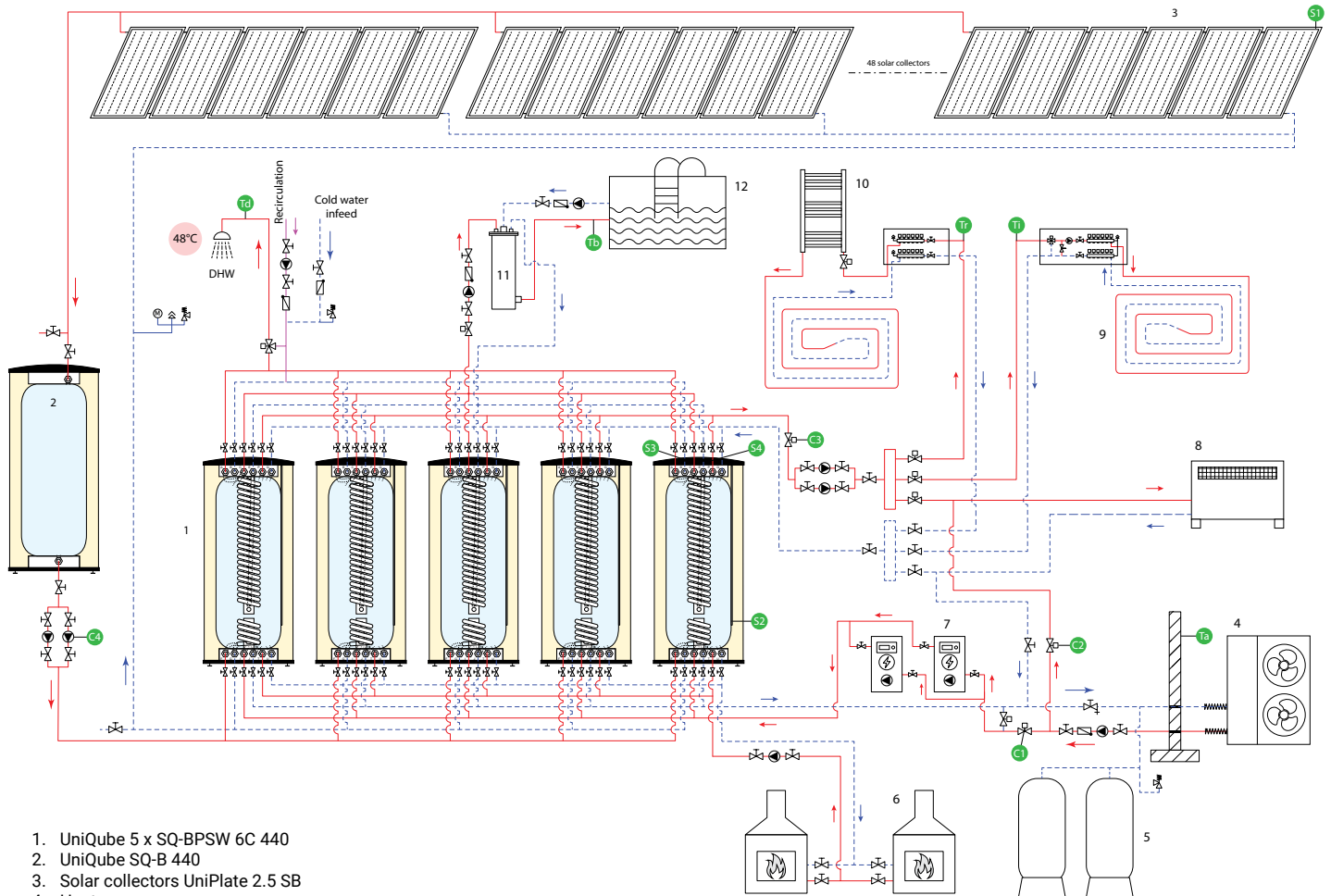

1. UniQube 5 x SQ-BPSW 6C 440
2. UniQube SQ-B 440
3. Solar collectors UniPlate 2.5 SB
4. Heat pump
5. Expansion vessels
6. Fireplace boiler
7. Electrical boiler
8. Fan coil units
9. Floor heating
10. Bathroom towel warmers
11. Swimming pool heat exchanger
12. Swimming pool

### SENSORS & CONTROLLER ELEMENTS

- C1 - Heat pump valve
- C2 - Fan coil units valve
- C3 - Heating valve
- C4 - Solar pump and valve
- S1 - Solar panels sensor
- S2, S3, S4 - Storage tank sensors



### UNIQUEST & PRIMARY CIRCUIT CONTROL

			C1	C2	C3	C4
	WINTER	Heat pump heating - ON	S4 < 40°C	S4 > 55°C	ON	ON
		Solar heating - ON	ON	OFF*		
	SUMMER	Heat pump cooling - ON	OFF		ON	ON
		Solar heating - ON	OFF			
		DHW back up heating with Electric Heater	OFF		OFF	
		DHW back up heating with heat pump	S4 < 40°C	S4 > 55°C	OFF	
			ON	OFF*		

\* Heat Pump high pressure protection if Solar DHW heating is set above 55°C



# UniQubes in serial connection, integrated with heat pump and solar heating for home systems

## BENEFITS

- Save up to 60% energy with A-class efficient UniQubes.
- 18kW solar power for the heating system, swimming pool and domestic hot water
- Free and unlimited hygienic hot water
- 100% of the available sunlight is used during the heating periods
- No overheating of the solar circuit during the summer.
- Hydraulic separation for comfort temperature regulation and extended lifetime of the pumps
- At least 20% higher annual system efficiency due to the thermal stratification
- Controlled by Solarico system controller

This connection diagram serves only as an installation suggestion and does not replace technical planning!

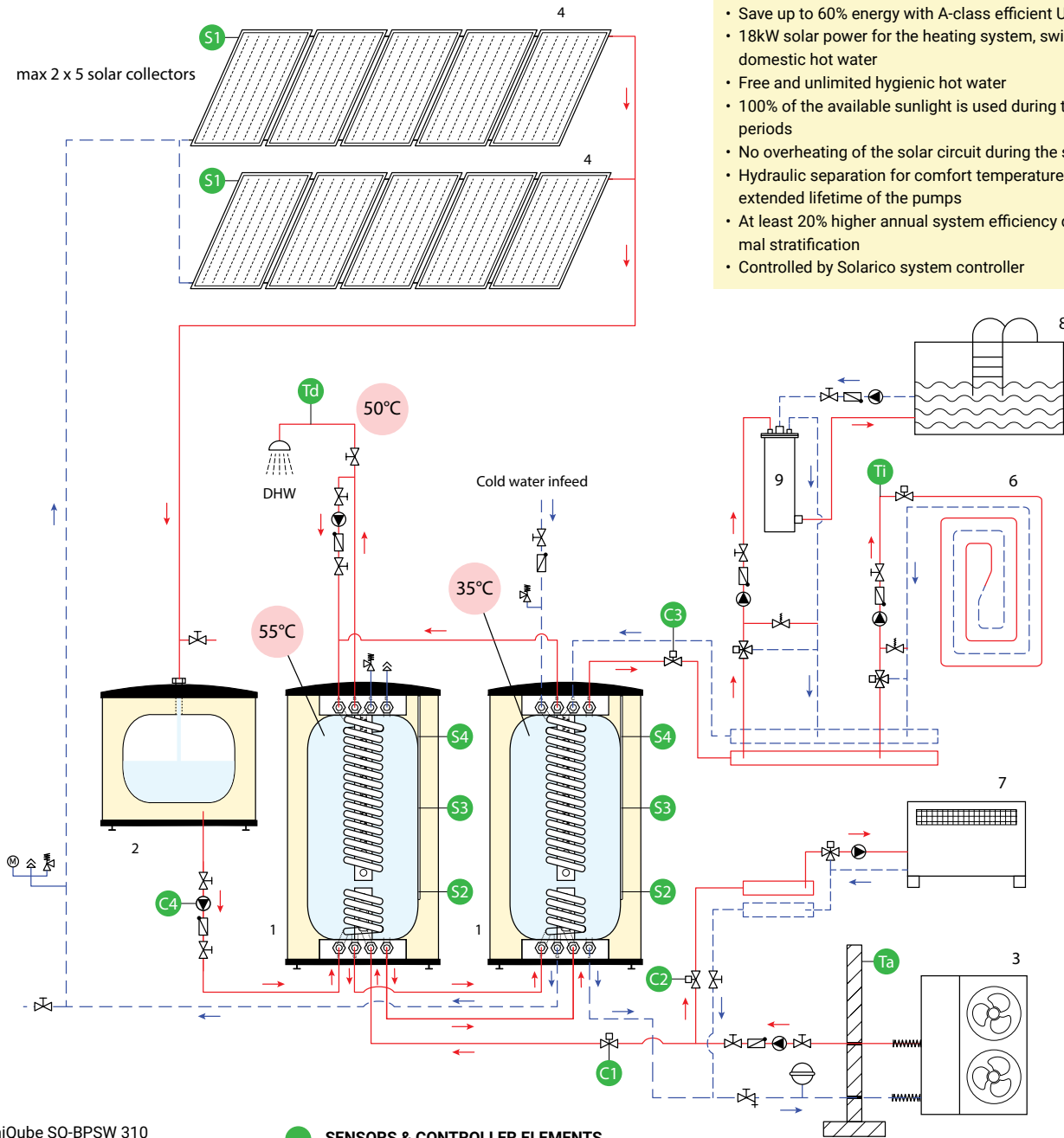

1. UniQube SQ-BPSW 310
2. UniQube Drain Back Reservoir DB
3. Heat pump
4. Solar collectors UniPlate 2.5 SB
6. Floor heating
7. Fan coil units
8. Swimming pool
9. Solarico Heat Exchanger

### SENSORS & CONTROLLER ELEMENTS

- C1 - Boiler pump/valve
- C2 - Fan coil units valve
- C3 - Heating valve
- C4 - Solar pump and valve
- S1 - Solar panels sensor
- S2, S3, S4 - Storage tank sensors



### UNIQUE & PRIMARY CIRCUIT CONTROL

			C1	C2	C3	C4
WINTER	Heat pump heating - ON Solar heating - ON	S4 < 40°C	S4 > 55°C	ON	ON	ON
		ON	OFF*			
SUMMER	Heat pump cooling - ON Solar heating - ON	OFF		ON	OFF	ON
	DHW back up heating with Electric Heater	OFF		ON		
	DHW back up heating with heat pump	S4 < 40°C	S4 > 55°C	OFF	OFF	
		ON	OFF*			

\* Heat Pump high pressure protection if Solar DHW heating is set above 55°C

### BENEFITS

- Save up to 60% energy with A-class efficient UniQubes
- 21kW solar power for the heating system, swimming pool and domestic hot water
- Free and unlimited hygienic hot water
- 100% of the available sunlight is used during the heating periods
- No overheating of the solar circuit during the summer
- Hydraulic separation for comfort temperature regulation and extended lifetime of the pumps
- At least 20% higher annual system efficiency due to the thermal stratification
- Controlled by Solarico system controller

This connection diagram serves only as an installation suggestion and does not replace technical planning!

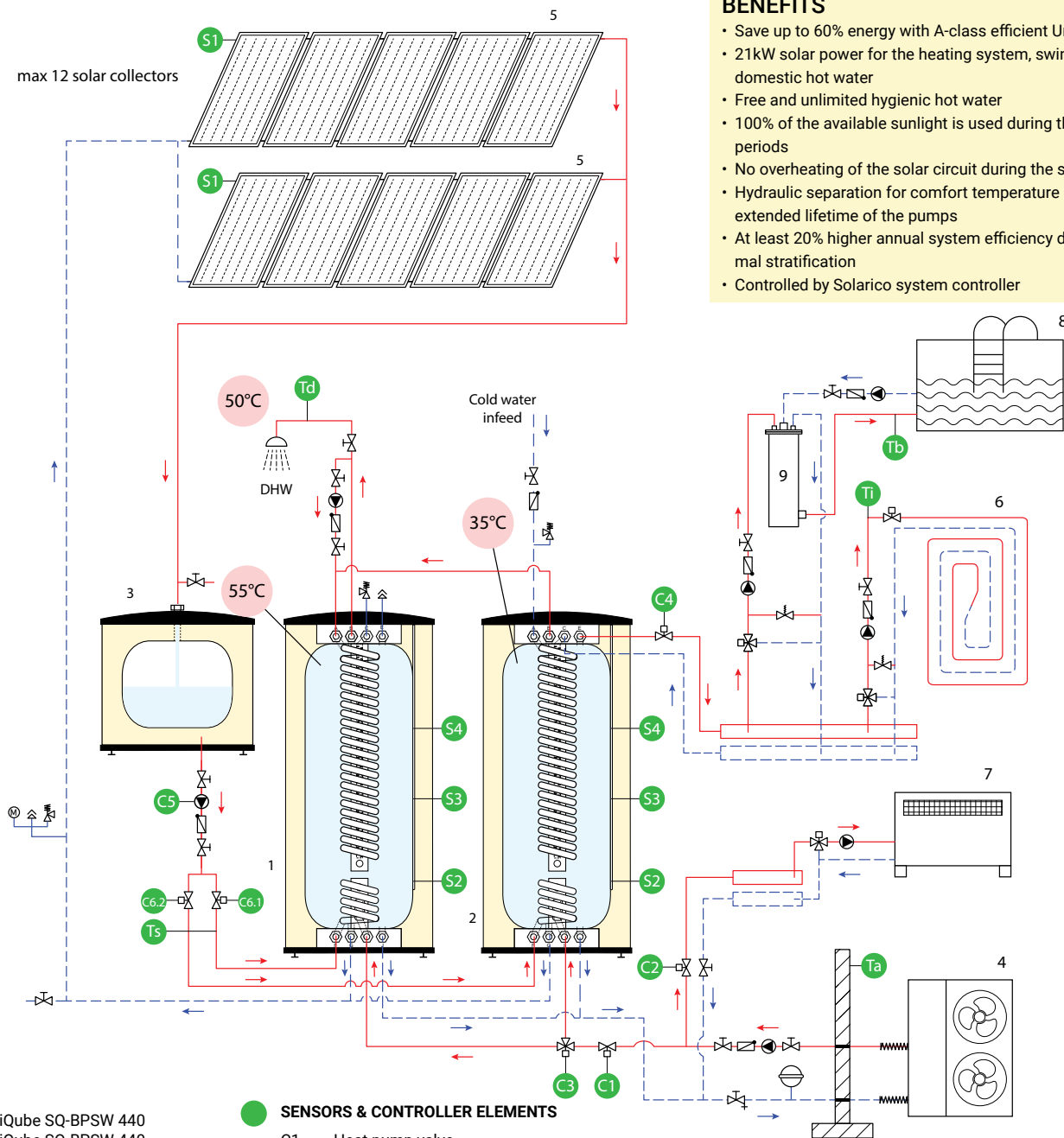

1. UniQube SQ-BPSW 440
2. UniQube SQ-BPSW 440
3. UniQube Drain Back Reservoir DB
4. Heat pump
5. Solar collectors UniPlate 2.5 SB
6. Floor heating
7. Fan coil units
8. Swimming pool
9. Solarico Heat Exchanger

### SENSORS & CONTROLLER ELEMENTS

- C1 - Heat pump valve
- C2 - Fan coil units valve
- C3 - Three-way valve
- C4 - Heating valve
- C6.1 - Solar valve for DHW
- C6.2 - Solar valve for heating
- S1 - Solar panels sensor
- S2, S3, S4 - Storage tank sensors

Solarico  
Wi-Fi Controller



### UNIQUEST & PRIMARY CIRCUIT CONTROL

			C1		C2	C3		C4	C6.1	C6.2	
			S4 < 40°C	S4 > 55°C		DHW (1)	Heating (2)				
	WINTER	Heat pump heating - ON Solar heating - ON	S4 < 40°C	S4 > 55°C	ON	S4 < 40°C	S4 > 55°C	ON	ON	ON	
			ON	OFF*		ON	ON				
	SUMMER	Heat pump cooling - ON Solar heating - ON	OFF		ON	ON	OFF	OFF	ON	OFF	
		DHW back up heating with Electric Heater	OFF								ON
		DHW back up heating with heat pump	S4 < 40°C	S4 > 55°C							OFF
			ON	OFF*							

\* Heat Pump high pressure protection if Solar DHW heating is set above 55°C

# DHW + Solar Drain Back + Heat Pump Qube X for home systems

## BENEFITS

- The underfloor heating may use solar heat - up to 50% energy savings
- 4 heat sources or 3 heat sources + 1 heat consumer may be connected
- Save up to 60% energy with A-class efficient Qube X
- Free and unlimited hygienic hot water.
- At least 20% higher annual system efficiency due to the thermal stratification
- Best COP regimes

This connection diagram serves only as an installation suggestion and does not replace technical planning!

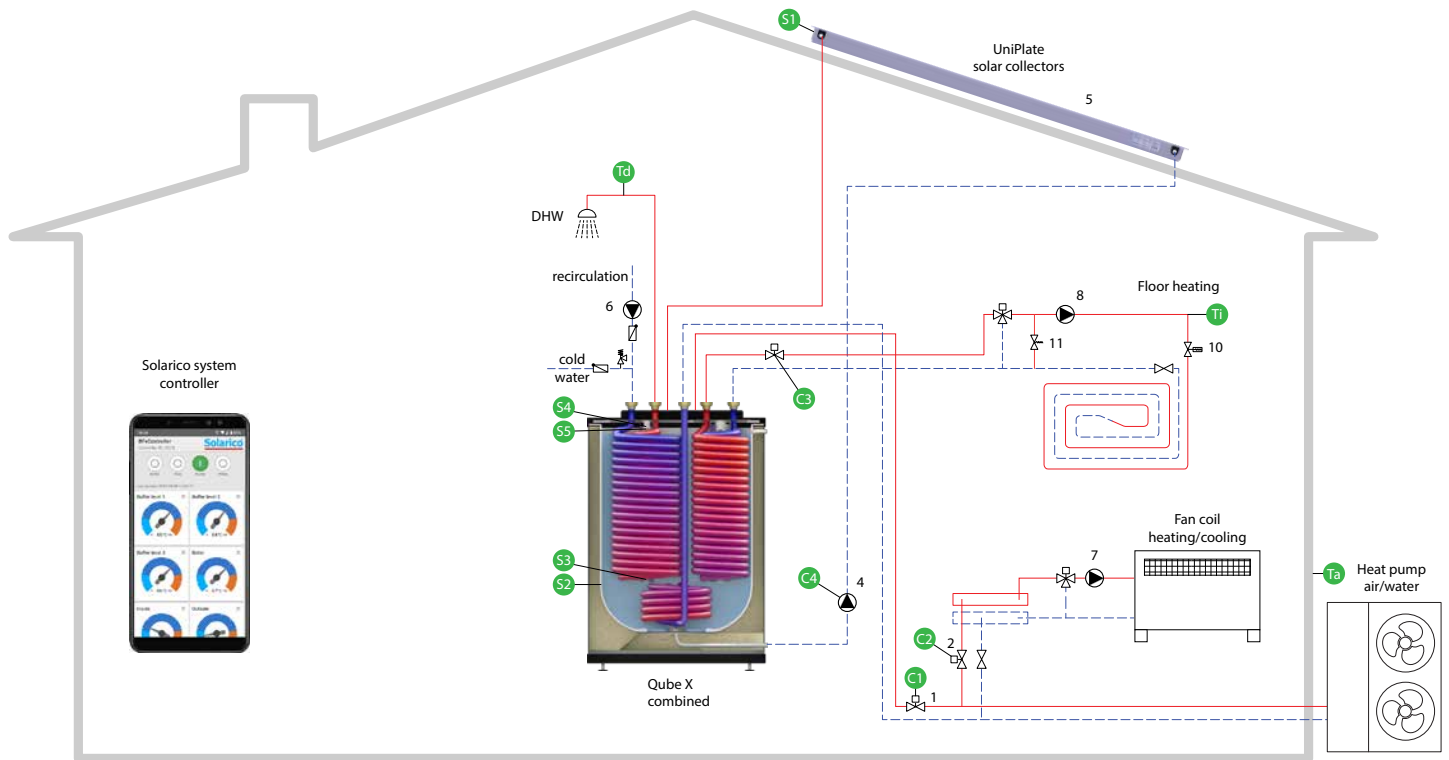

### PRIMARY CIRCUITS

(hot/cold water sources)

1. Heat pump valve
2. Fan coil valve
3. Heating valve
4. Solar system pump station
5. Solar thermal panels

### SECONDARY CIRCUITS

(hot/cold water consumers)

7. Circulation pump for fan coils
8. Circulation pump for floor heating
10. Individual room control/thermostat valve
11. Differential pressure / bypass valve

### SENSORS & CONTROLLER ELEMENTS

- C1 - Heat pump valve
- C2 - Fan coil units valve
- C3 - Heating valve
- C4 - Solar system station
- S1 - Solar panels sensor
- S2, S3, S4 - Storage tank sensors
- Ta - External temperature sensor
- Td - DHW sensor
- Ti - Floor temperature limiter

### QUBE X & PRIMARY CIRCUIT CONTROL

			C1		C2	C3
	WINTER heating and shower regime 45°C/40°C	Heat Pump heating - ON Solar heating - ON Output temperature 45°C DHW temperature 40°C	S4 < 40°C	S4 > 55°C	ON	ON
			ON	OFF*		
	SUMMER cooling regime	Heat pump cooling - ON Output Temperature is 7°C Heat Pump DHW Temperature is set to 50°C Solar DHW Temperature is set to 65°C	OFF		ON	OFF
	SUMMER shower regime 55°C/50°C (on user's or sensor S4 request)	Heat Pump heating - ON Output temperature 55°C Heat Pump DHW temperature 50°C Solar DHW temperature is set to 65°C	S4 < 40°C	S4 > 55°C	OFF	OFF

\* Heat Pump high pressure protection if Solar DHW heating is set above 55°C

**BENEFITS**

- Save up to 60% energy with A-class efficient Qube X
- Free and unlimited hygienic hot water
- Up to 2 electric heating elements

This connection diagram serves only as an installation suggestion and does not replace technical planning!

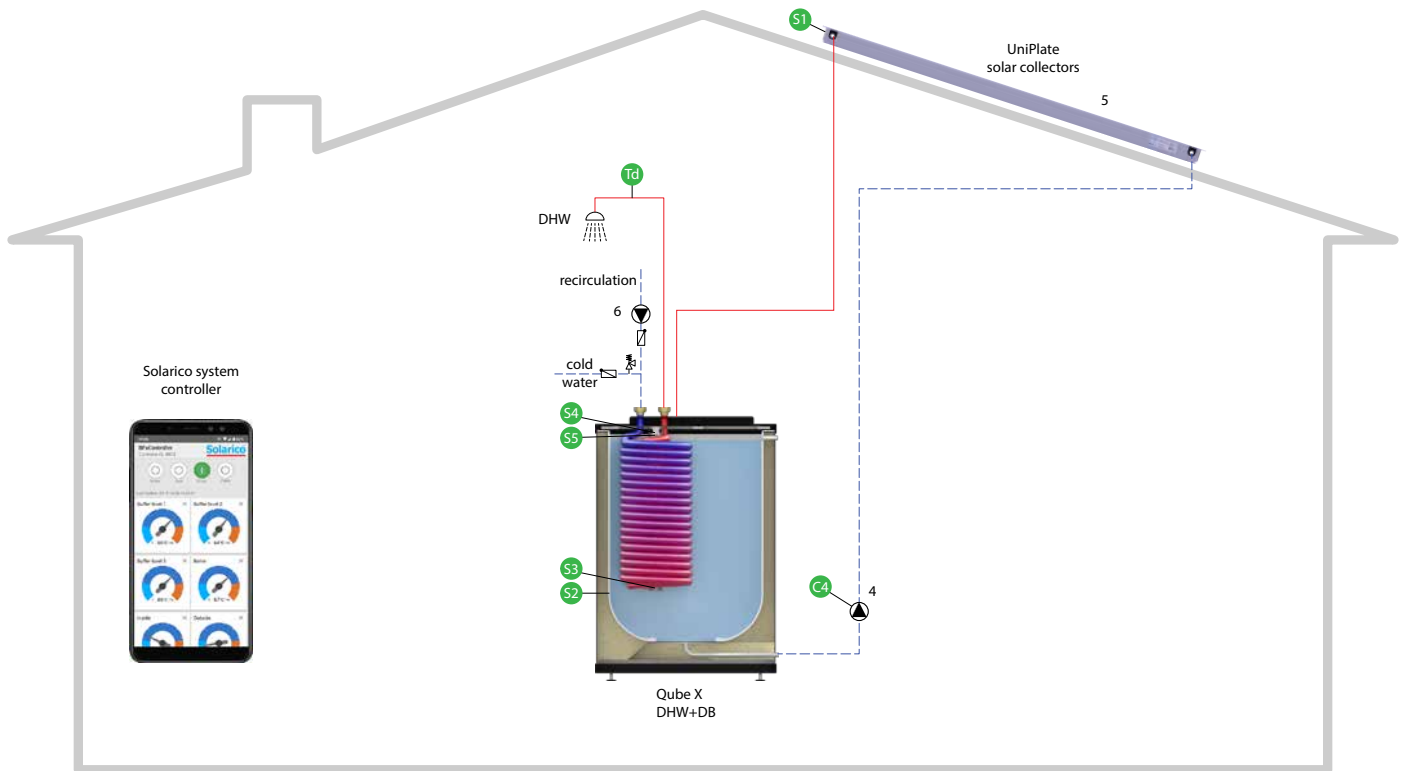

**PRIMARY CIRCUITS**

- (hot/cold water sources)
4. Solar system pump station
  5. Solar thermal panels

**SENSORS & CONTROLLER ELEMENTS**

- C4 - Solar system station
- S1 - Solar panels sensor
- S2, S3, S4 - Storage tank sensors

**QUBE X & PRIMARY CIRCUIT CONTROL**

			C4
	<b>WINTER / SUMMER</b> heating and shower regime	Solar heating - ON	$(S4 + 10^{\circ}\text{C}) < S1$ and $S4 < T_{set}$
			ON

\* Heat Pump high pressure protection if Solar DHW heating is set above 55°C

# Solar and Heat Pump - All in One solution

## UniQube for home systems

### GET MORE THAN A-CLASS EFFICIENCY

**The Inputs** - Heat Pump and Solar Thermal

**The Outputs** - Heating and Hygienic Hot Water

**Inside** - Thermal Stratification and Hydraulic Separation

### BENEFITS

- Save up to 60% energy with A-class efficient UniQubes
- Free sun power for Home Heating
- Free sun power for Hygienic Hot Water
- Instant hygienic hot water
- Comfort temperature regulation for each room
- Improving the lifetime of pumps
- Improving the lifetime of heat source
- Heat storage during the cheap tariff
- Storage of the excessive sun heat
- Improved annual system efficiency by 20% and more

This connection diagram serves only as an installation suggestion and does not replace technical planning!

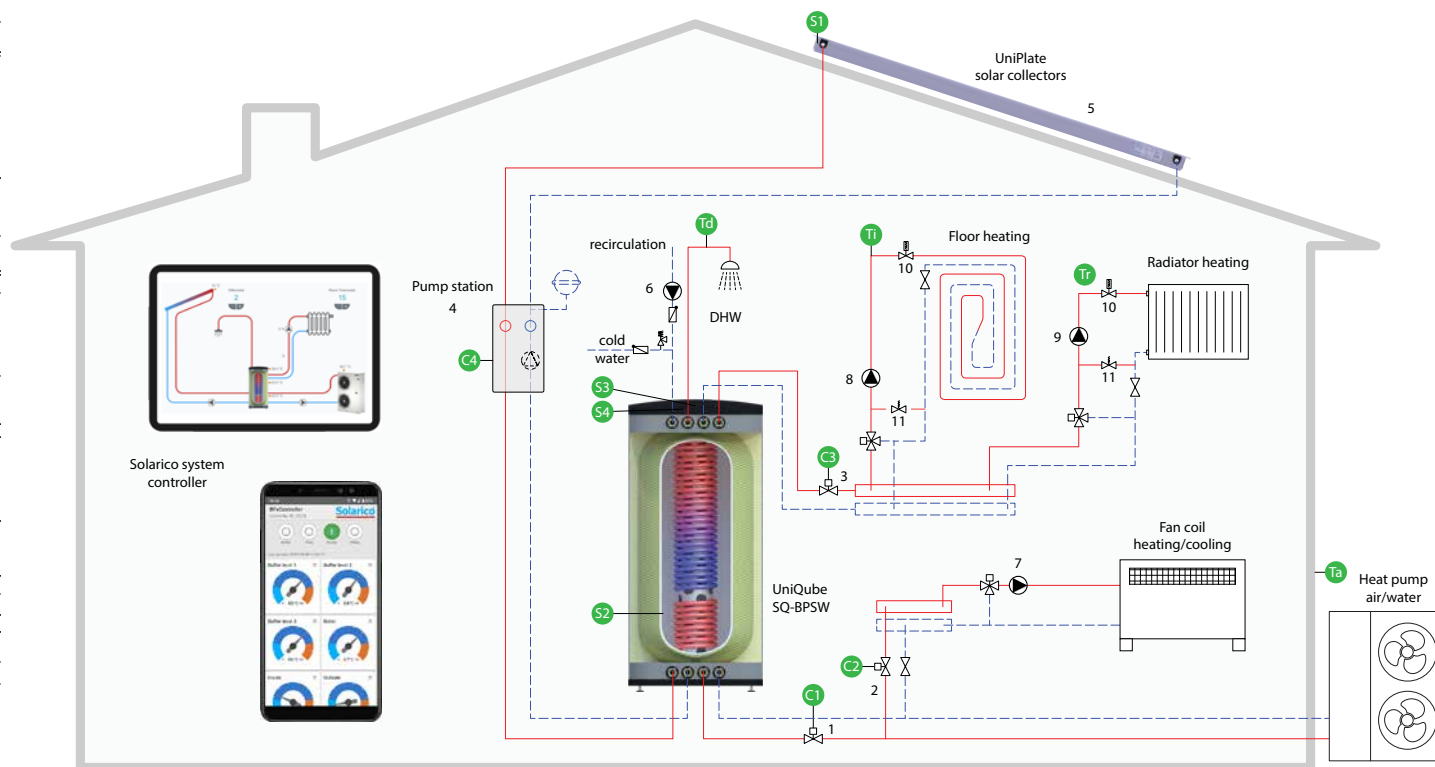

#### PRIMARY CIRCUITS

(hot/cold water sources)

1. Heat pump valve
2. Fan coil valve
3. Heating valve
4. Solar system pump station
5. Solar thermal panels

#### SECONDARY CIRCUITS

(hot/cold water consumers)

7. Circulation pump for fan coils
8. Circulation pump for floor heating
9. Circulation pump for radiator heating
10. Individual room control/thermostat valve
11. Differential pressure / bypass valve

#### SENSORS & CONTROLLER ELEMENTS

- C1 - Heat pump valve
- C2 - Fan coil units valve
- C3 - Heating valve
- C4 - Solar system station
- S1 - Solar panels sensor
- S2, S3, S4 - Storage tank sensors
- Ta - External temperature sensor
- Td - DHW sensor
- Ti - Floor temperature limiter
- Tr - Individual room control

#### UNIQUBE & PRIMARY CIRCUIT CONTROL

			C1		C2	C3	C4
❄️	WINTER	Heat pump heating - ON	S4 < 40°C	S4 > 55°C	ON	ON	ON
		Solar heating - ON	ON	OFF*			
☀️	SUMMER	Heat pump cooling - ON	OFF		ON	OFF	ON
		Solar heating - ON	OFF				
		DHW back up heating with Electric Heater	S4 < 40°C	S4 > 55°C	OFF	OFF	
DHW back up heating with heat pump	ON	OFF*					

\* Heat Pump high pressure protection if solar DHW heating is set above 55°C

## GET MORE THAN A-CLASS EFFICIENCY

**The Inputs** - Heat Pump and Solar Thermal

**The Outputs** - Heating and Hygienic Hot Water

**Inside** - Thermal Stratification and Hydraulic Separation

### BENEFITS

- Suitable for systems with irregular hot water consumption like hospitality industry
- No overheating in summer and no freezing in winter
- Supports installation of more collectors than conventional solar systems
- Real free solar heating for your home
- Save up to 60% energy with A-class efficient UniQubes
- Free sun power for Hygienic Hot Water
- Instant hygienic hot water
- Comfort temperature regulation for each room
- Improving the lifetime of pumps
- Improving the lifetime of heat source
- Heat storage during the cheap tariff
- Storage of the excessive sun heat
- Improved annual system efficiency by 20% and more

This connection diagram serves only as an installation suggestion and does not replace technical planning!

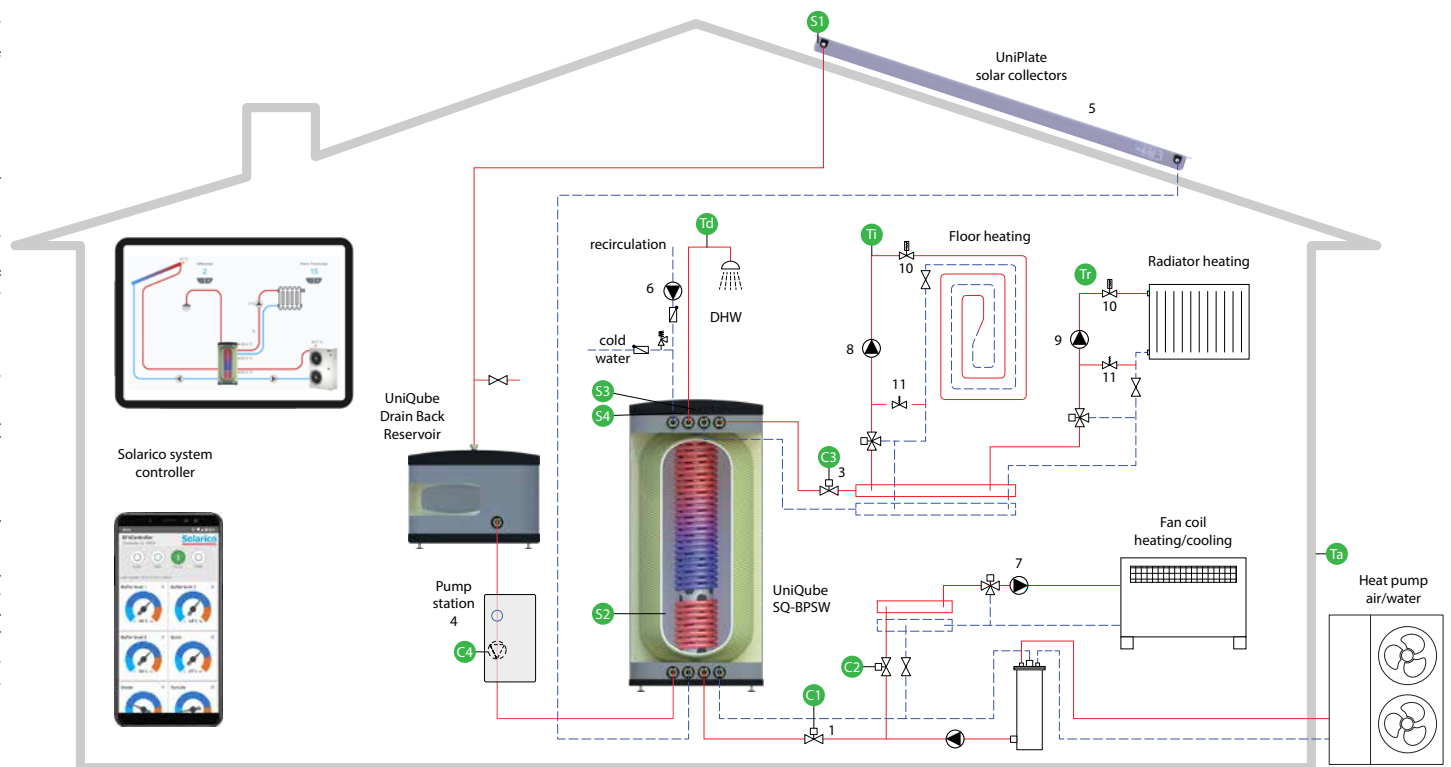

### PRIMARY CIRCUITS (hot/cold water sources)

1. Heat pump valve
2. Fan coil valve
3. Heating valve
4. Solar system pump station
5. Solar thermal panels

### SECONDARY CIRCUITS (hot/cold water consumers)

7. Circulation pump for fan coils
8. Circulation pump for floor heating
9. Circulation pump for radiator heating
10. Individual room control/thermostat valve
11. Differential pressure / bypass valve

### SENSORS & CONTROLLER ELEMENTS:

- |                           |                                   |
|---------------------------|-----------------------------------|
| C1 - Heat pump valve      | S1 - Solar panels sensor          |
| C2 - Fan coil units valve | S2, S3, S4 - Storage tank sensors |
| C3 - Heating valve        | Ta - External temperature sensor  |
| C4 - Solar system station | Td - DHW sensor                   |
|                           | Ti - Floor temperature limiter    |
|                           | Tr - Individual room control      |

### UNIUBE & PRIMARY CIRCUIT CONTROL

			C1		C2	C3	C4
	WINTER	Heat pump heating - ON	S4 < 40°C	S4 > 55°C	ON	ON	ON
		Solar heating - ON	ON	OFF*			
	SUMMER	Heat pump cooling - ON	OFF		ON	OFF	ON
		Solar heating - ON	OFF				
		DHW back up heating with Electric Heater	S4 < 40°C	S4 > 55°C	OFF	OFF	
DHW back up heating with heat pump	ON	OFF*					

\* Heat Pump high pressure protection if Solar DHW heating is set above 55°C

# Composite Expansion Vessels Integration in heating systems

This connection diagram serves only as an installation suggestion and does not replace technical planning!

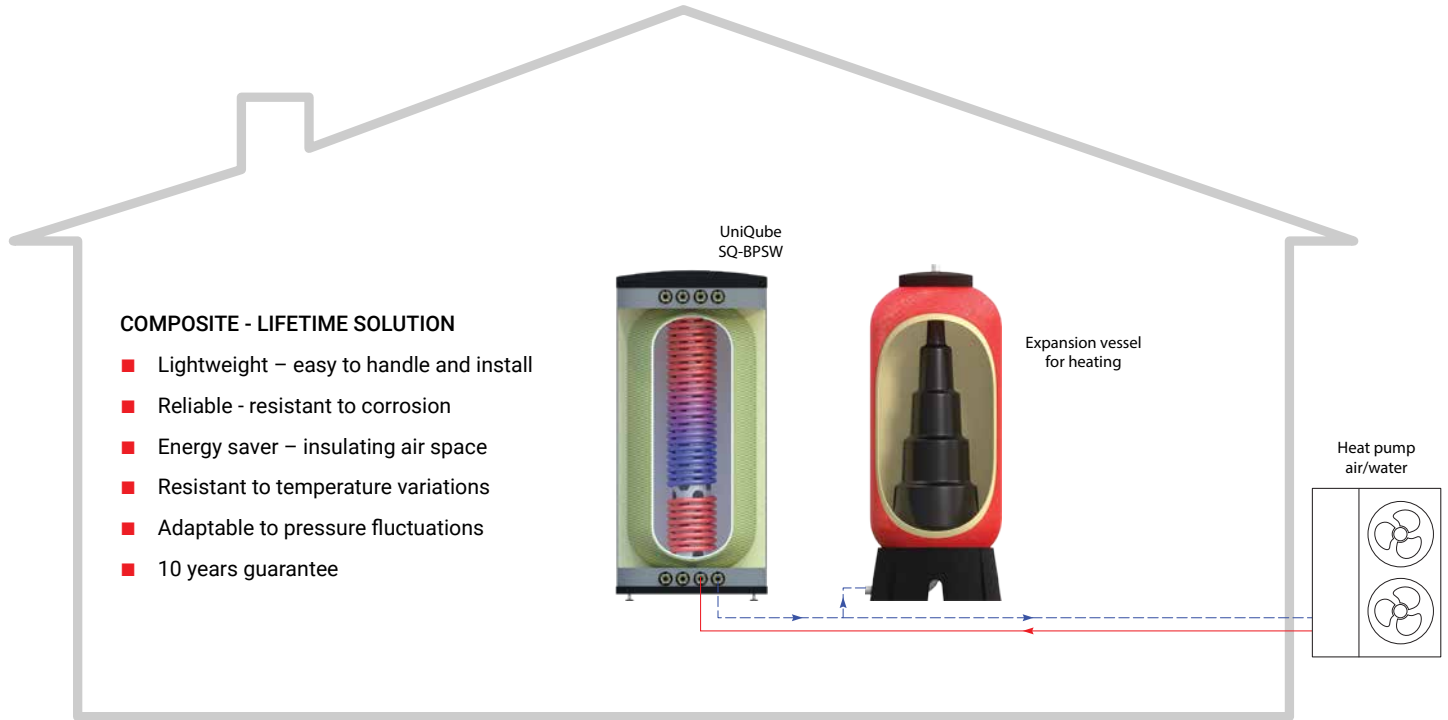

# Composite Expansion Vessels Integration in potable water systems

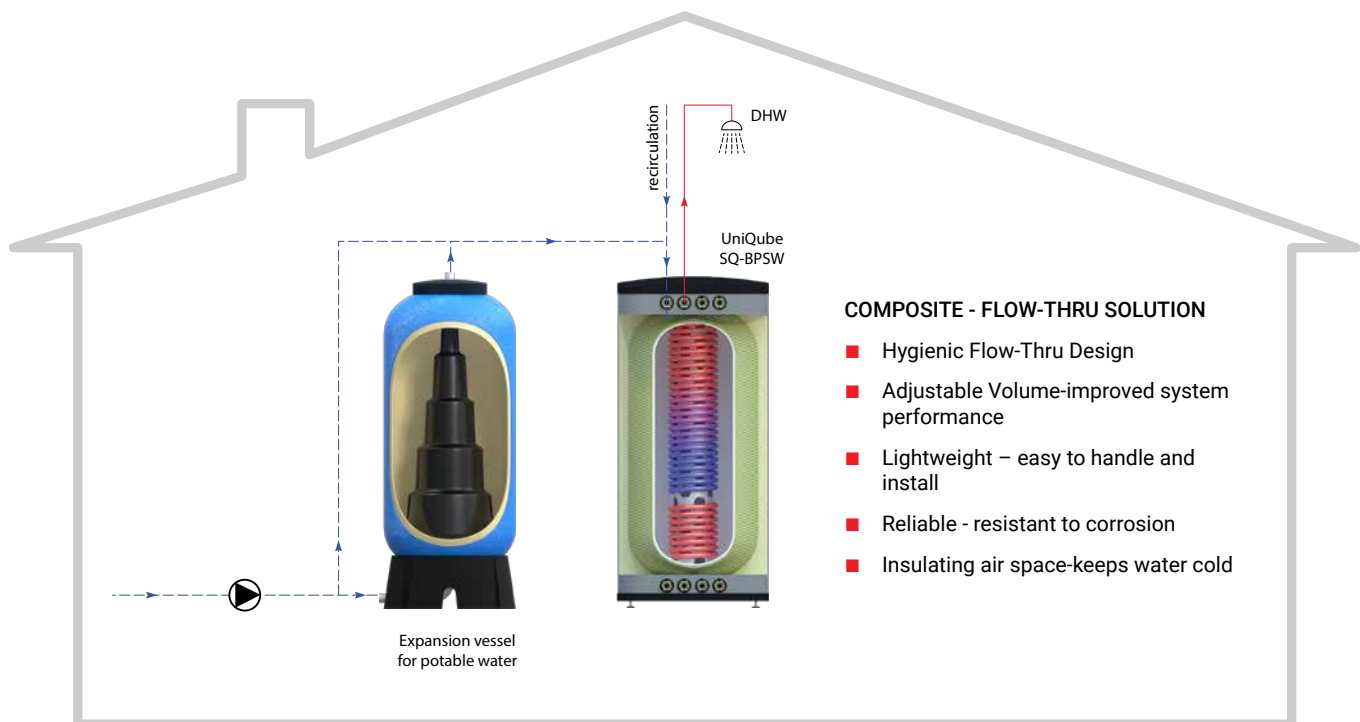

# Solarico®

INNOVATIVE  
PLASTIC COMPOSITE  
NEW GENERATION

HYGIENIC WATER HEATER  
DRAINBACK SOLAR STORAGE TANK  
STRATIFIED SEPARATOR ACCUMULATOR



- Solar Thermal Collectors
- Multi-Functional Storage Tanks and Hygienic Water Heaters
- Drain Back Reservoirs
- Expansions Vessels
- Pressure Vessels
- Heat Exchangers



## PRODUCTION FACILITY:

📍 Euroterm d.o.o.  
Lece Koteski 50  
Industrial area Biljana  
7500 Prilep  
R. North Macedonia

✉ info@solarico.eu  
🌐 www.solarico.eu  
☎ +389 75 463 929  
☎ +389 48 419 415  
📠 +389 48 422 981

